



ArrowWorthy®



CREATIVE
PRODUCTS
for the MODERN
PAINTER

Catalog No. 52

Anatomy of an *ArroWorthy* Brush

**Professionally Designed
Quality Materials**

It's what makes ArroWorthy Brushes Second to None



Choose the Best Chinese Bristle Paint Brush

- Hard Wood Handle
- Stainless Steel Ferrule
- Blend of the Finest Natural Bristles
- Wood Spacers, the Smaller the Better- No Cardboard Spacers
- Solvent resistant Epoxy Setting
- Aluminum Insert for Extra Strength
- Form Chisel for Better Brush Out and Cutting In
- Bent Trimming For Better Cutting In
- Hand Wash & Shaping For Better All Around Painting
- Tapered Keepers For Better holding The Shape of the Brush

Choose the Best Synthetic Filament Paint Brush

- Hard Wood Handle
- Stainless Steel Ferrule
- 100% Solid Round Tapered Filament
- Wood Spacers, the Smaller the Better- No Cardboard Spacers
- Solvent resistant Epoxy Setting
- Aluminum Insert for Extra Strength
- Form Chisel for Better Brush Out and Cutting In
- Bent Trimming For Better Cutting In
- Tapered Shaping For Better Control When Trimming
- Tapered Keepers For Better holding The Shape of the Brush

Anatomy of an *ArroWorthy* Roller

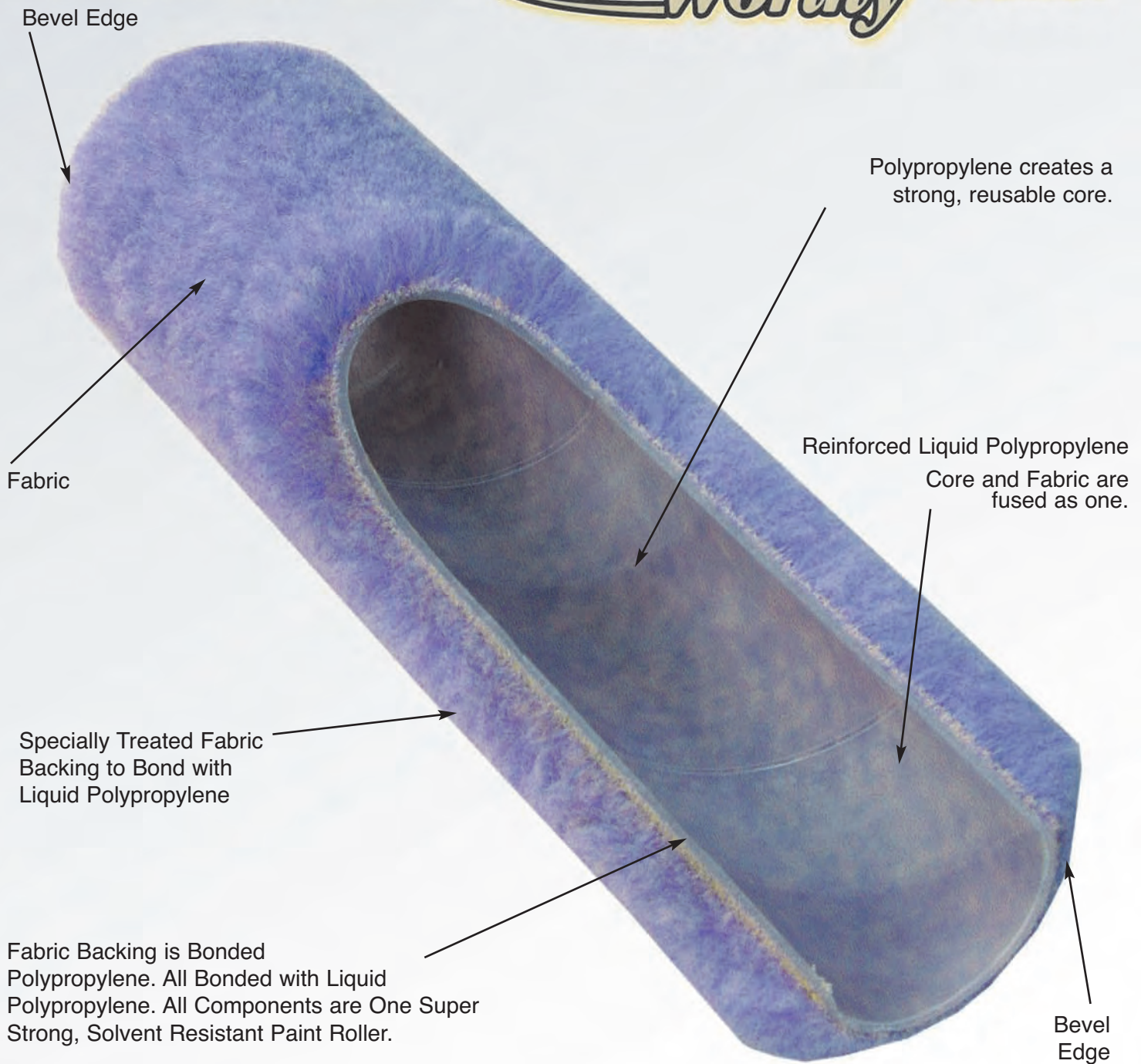

Choose the Best Synthetic Roller Cover

- Reinforced Polypropylene Core.
- Bevel trimming eliminates paint dumping.

**Professionally Designed
Quality Materials
It's what makes ArroWorthy Rollers Second to None**

“FINULTRA™” PROFESSIONAL Finultra™ Solid Round Tapered Nylon/Polyester



PRO BRUSHES

3510 - Flat Sash



- Form Chisel
- Natural Wood Handle
- Stainless Steel Ferrule

Size	Trim Length	Thickness	Pack/Box	UPC: 740962-
1-1/2"	2-3/4"	1/2"	12	30485-2
2"	3"	9/16"	12	30486-9
2-1/2"	3-1/4"	5/8"	12	30487-6
3"	3-1/2"	11/16"	12	30488-3

3520 - Angular Sash



- Form Chisel
- Natural Wood Handle
- Stainless Steel Ferrule

Size	Trim Length	Thickness	Pack/Box	UPC: 740962-
1-1/2"	2-3/4"	1/2"	12	30489-0
2"	3"	9/16"	12	30490-6
2-1/2"	3-1/4"	5/8"	12	30491-3
3"	3-1/2"	11/16"	12	30492-0

3560 - Rattail Angular Flat End Sash



- Form Chisel
- Natural Wood Handle
- Stainless Steel Ferrule

Size	Trim Length	Thickness	Pack/Box	UPC: 740962-
1-1/2"	2-1/4"	3/8"	12	30520-0
2"	2-1/2"	7/16"	12	30521-7
2-1/2"	2-3/4"	1/2"	12	30522-4
3"	3"	1/2"	12	30523-1

3530 - Varnish



- Form Chisel
- Natural Wood Handle
- Stainless Steel Ferrule

Size	Trim Length	Thickness	Pack/Box	UPC: 740962-
2"	3"	9/16"	12	30493-7
2-1/2"	3-1/4"	5/8"	12	30494-4
3"	3-1/2"	11/16"	12	30495-1

3556 - Square End Wall



- Form Chisel
- Natural Wood Handle
- Stainless Steel Ferrule

Size	Trim Length	Thickness	Pack/Box	UPC: 740962-
3"	3-3/4"	7/8"	6	30496-8
4"	4"	7/8"	6	30497-5

Solid Round Tapered Polyester/Nylon

PRO BRUSHES

4010 - Professional Flat Sash

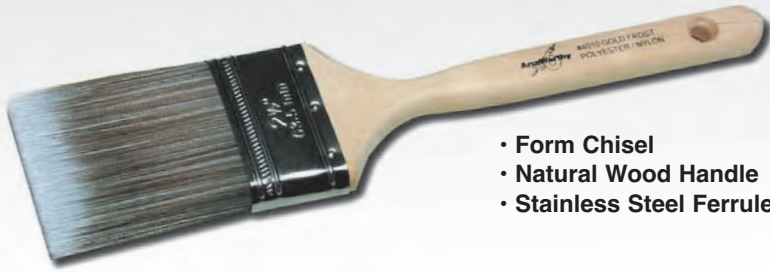

- Form Chisel
- Natural Wood Handle
- Stainless Steel Ferrule

Size	Trim Length	Thickness	Pack/Box	UPC: 740962-
1"	2-1/4"	7/16"	12	30079-3
1-1/2"	2-1/2"	1/2"	12	30080-9
2"	2-3/4"	9/16"	12	30081-6
2-1/2"	3"	5/8"	12	30082-3
3"	3-1/4"	11/16"	12	30083-0

4020 - Professional Angular Sash



- Form Chisel
- Natural Wood Handle
- Stainless Steel Ferrule

Size	Trim Length	Thickness	Pack/Box	UPC: 740962-
1"	2-1/4"	7/16"	12	30086-1
1-1/2"	2-1/2"	1/2"	12	30089-8
2"	2-3/4"	9/16"	12	30088-5
2-1/2"	3"	5/8"	12	30089-2
3"	3-1/4"	11/16"	12	30090-8
3-1/2"	3-1/2"	11/16"	12	30331-2

4030 - Professional Varnish



- Form Chisel
- Beavertail Natural Wood Handle
- Stainless Steel Ferrule

Size	Trim Length	Thickness	Pack/Box	UPC: 740962-
2"	2-3/4"	9/16"	12	30092-2
2-1/2"	3"	5/8"	12	30093-9
3"	3-1/4"	11/16"	12	30094-6

4060 - Rattail Angular Flat End Sash



- Form Chisel
- Natural Wood Handle
- Stainless Steel Ferrule

Size	Trim Length	Thickness	Pack/Box	UPC: 740962-
1"	2"	5/16"	12	30361-9
1-1/2"	2-1/4"	3/8"	12	30362-6
2"	2-1/2"	7/16"	12	30098-4
2-1/2"	2-3/4"	1/2"	12	30099-1
3"	3"	1/2"	12	30100-4

4056 - Professional Square End Wall



- Form Chisel
- Natural Wood Handle
- Stainless Steel Ferrule

Size	Trim Length	Thickness	Pack/Box	UPC: 740962-
3"	3-1/2"	7/8"	6	30096-0
4"	3-3/4"	7/8"	6	30097-7

“RED FROST™” PROFESSIONAL



HG™ Solid Round Tapered Polyester/Nylon

2010 - Professional Flat Sash



- Firm Blend
- Form Chisel
- Natural Wood Handle
- Stainless Steel Ferrule

Size	Trim Length	Thickness	Pack/Box	UPC: 740962-
1"	2-1/4"	7/16"	12	30040-3
1-1/2"	2-1/2"	1/2"	12	30041-0
2"	2-3/4"	9/16"	12	30042-7
2-1/2"	3"	5/8"	12	30043-4
3"	3-1/4"	11/16"	12	30044-1

2016 - Square End Flat Sash



- Firm Blend
- Form Chisel
- Natural Wood Handle
- Stainless Steel Ferrule

Size	Trim Length	Thickness	Pack/Box	UPC: 740962-
2"	3"	11/16"	12	30340-4
2-1/2"	3-1/4"	3/4"	12	30341-1
3"	3-1/2"	3/4"	12	30342-8

2020 - Professional Angular Sash



- Firm Blend
- Form Chisel
- Natural Wood Handle
- Stainless Steel Ferrule

Size	Trim Length	Thickness	Pack/Box	UPC: 740962-
1"	2-1/4"	7/16"	12	30050-2
1-1/2"	2-1/2"	1/2"	12	30051-9
2"	2-3/4"	9/16"	12	30052-6
2-1/2"	3"	5/8"	12	30053-3
3"	3-1/4"	11/16"	12	30054-0
3-1/2"	3-1/2"	11/16"	12	30338-1

2060 - Rattail Angular Flat End Sash



- Form Chisel
- Natural Wood Handle
- Stainless Steel Ferrule

Size	Trim Length	Thickness	Pack/Box	UPC: 740962-
1"	2"	5/16"	12	30465-4
1-1/2"	2-1/4"	3/8"	12	30466-1
2"	2-1/2"	7/16"	12	30467-8
2-1/2"	2-3/4"	1/2"	12	30468-5
3"	3"	1/2"	12	30469-2

2030 - Beavertail Varnish



- Firm Blend
- Form Chisel
- Natural Wood Handle
- Stainless Steel Ferrule

Size	Trim Length	Thickness	Pack/Box	UPC: 740962-
2"	2-3/4"	9/16"	12	30061-8
2-1/2"	3"	5/8"	12	30062-5
3"	3-1/4"	11/16"	12	30063-2

2056 - Square End Wall



- Firm Blend
- Form Chisel
- Natural Wood Handle
- Stainless Steel Ferrule

Size	Trim Length	Thickness	Pack/Box	UPC: 740962-
3"	3-1/2"	7/8"	6	30333-6
3-1/2"	3-1/2"	7/8"	6	30335-0
4"	3-3/4"	7/8"	6	30334-3

“GOLD FROST™ PLUS” PROFESSIONAL



Solid Round Tapered Polyester/Nylon

PRO BRUSHES

4110 - Professional Flat Sash



- Form Chisel
- Natural Wood Handle
- Stainless Steel Ferrule

Size	Trim Length	Thickness	Pack/Box	UPC: 740962-
2"	2-3/4"	9/16"	12	30601-6
2-1/2"	3"	5/8"	12	30602-3
3"	3-1/4"	11/16"	12	30603-0

4120 - Professional Angular Sash



- Form Chisel
- Natural Wood Handle
- Stainless Steel Ferrule

Size	Trim Length	Thickness	Pack/Box	UPC: 740962-
2"	2-3/4"	9/16"	12	30606-1
2-1/2"	3"	5/8"	12	30607-8
3"	3-1/4"	11/16"	12	30608-5

4156 - Professional Square End Wall



- Form Chisel
- Natural Wood Handle
- Stainless Steel Ferrule

Size	Trim Length	Thickness	Pack/Box	UPC: 740962-
3"	3-1/2"	7/8"	6	30610-8
4"	3-3/4"	7/8"	6	30611-5



“CLASSIC” PROFESSIONAL Pro-Line Black China Bristle



1010 - Flat Sash

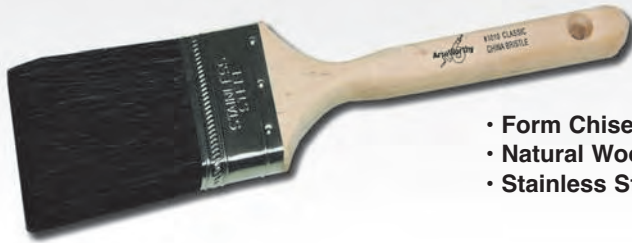

- Form Chisel
- Natural Wood Handle
- Stainless Steel Ferrule

Size	Trim Length	Thickness	Pack/Box	UPC: 740962-
1"	2-3/8"	7/16"	12	30001-4
1-1/2"	2-5/8"	1/2"	12	30002-1
2"	2-7/8"	9/16"	12	30003-8
2-1/2"	3-1/8"	5/8"	12	30004-5
3"	3-3/8"	11/16"	12	30005-2

1020 - Angular Sash



- Form Chisel
- Natural Wood Handle
- Stainless Steel Ferrule

Size	Trim Length	Thickness	Pack/Box	UPC: 740962-
1"	2-3/8"	7/16"	12	30013-7
1-1/2"	2-3/8"	1/2"	12	30014-4
2"	2-5/8"	9/16"	12	30015-1
2-1/2"	2-7/8"	5/8"	12	30016-8
3"	3-1/8"	11/16"	12	30017-5

1060 - Rattail Angular Square End Sash



- Form Chisel
- Natural Wood Handle
- Stainless Steel Ferrule

Size	Trim Length	Thickness	Pack/Box	UPC: 740962-
1"	2"	5/16"	12	30336-7
1-1/2"	2-1/4"	3/8"	12	30337-4
2"	2-3/8"	7/16"	12	30031-1
2-1/2"	2-5/8"	1/2"	12	30032-8
3"	2-7/8"	1/2"	12	30033-5

1030 - Beavertail Varnish



- Form Chisel
- Beavertail Natural Wood Handle
- Stainless Steel Ferrule

Size	Trim Length	Thickness	Pack/Box	UPC: 740962-
2"	2-7/8"	9/16"	12	30024-3
2-1/2"	3-1/8"	5/8"	12	30025-0
3"	3-3/8"	11/16"	12	30026-7

1050 - Wall



- Form Chisel
- Natural Wood Handle
- Stainless Steel Ferrule

Size	Trim Length	Thickness	Pack/Box	UPC: 740962-
3"	3-5/8"	1"	6	30027-4
3-1/2"	3-7/8"	1"	6	30028-1
4"	4-1/8"	1"	6	30029-8

“WHITE PEARL™” PROFESSIONAL

Pro-Line White China Bristle



1015 - Flat Sash



- Form Chisel
- Natural Wood Handle
- Stainless Steel Ferrule

Size	Trim Length	Thickness	Pack/Box	UPC: 740962-
1-1/2"	2-3/8"	1/2"	12	30145-5
2"	2-5/8"	9/16"	12	30144-8
2-1/2"	2-7/8"	5/8"	12	30144-5
3"	3-1/8"	11/16"	12	30146-2

1025 - Angular Sash



- Form Chisel
- Natural Wood Handle
- Stainless Steel Ferrule

Size	Trim Length	Thickness	Pack/Box	UPC: 740962-
1-1/2"	2-3/8"	1/2"	12	30147-9
2"	2-5/8"	9/16"	12	30148-6
2-1/2"	2-7/8"	5/8"	12	30149-3
3"	3-1/8"	11/16"	12	30150-9

1035 - Beavertail Varnish



- Form Chisel
- Natural Wood Handle
- Stainless Steel Ferrule

Size	Trim Length	Thickness	Pack/Box	UPC: 740962-
1-1/2"	2-3/8"	1/2"	12	30151-6
2"	2-5/8"	9/16"	12	30152-3
2-1/2"	2-7/8"	5/8"	12	30153-0
3"	3-1/8"	11/16"	12	30154-7

“CAP N JACK” PROFESSIONAL



5045 - White China Bristle



- Premium White China Bristle
- Comfortable Pencil Handle
- Ideal for Enamel, Varnish, Paints and Stains

Size	Trim Length	Thickness	Pack/Box	UPC: 740962-
1"	2-1/4"	5/16"	12	30545-3
1-1/2"	2-1/2"	1/2"	12	30546-0
2"	2-3/4"	9/16"	12	30547-7
2-1/2"	3"	5/8"	12	30548-4
3"	3"	11/16"	12	30549-1

“BADGER” PROFESSIONAL

Pro-Line White China Bristle



1045 - Badger Varnish



- Form Chisel
- Lacquered Round Peg Handle
- Stainless Steel Ferrule

Size	Trim Length	Thickness	Pack/Box	UPC: 740962-
1"	1-3/4"	5/16"	12	30330-5
1-1/2"	1-15/16"	1/2"	12	30284-1
2"	1-15/16"	9/16"	12	30285-8
2-1/2"	2-1/8"	5/8"	12	30286-5
3"	2-1/8"	11/16"	12	30287-2

PRO BRUSHES

"BRISTLE OX" PROFESSIONAL



1069- Handle



- Angle Sash
- Chiseled Trim
- Natural Wood Rattail Handle
- Steel Ferrule
- Very Fine China Bristle with Ox Hair Feel

Size	Trim Length	Thickness	Pack/Box	UPC: 740962-
2"	2-1/2"	7/16"	12	30525-5
2-1/2"	2-3/4"	1/2"	12	30526-2
3"	3"	9/16"	12	30527-9

1059 - Handle



- Flat Sash
- Chiseled Trim
- Natural Wood Handle
- Steel Ferrule
- Very Fine China Bristle with Ox Hair Feel

Size	Trim Length	Thickness	Pack/Box	UPC: 000000-
2"	2-1/2"	7/16"	12	30528-6
2-1/2"	2-3/4"	1/2"	12	30529-3
3"	3"	9/16"	12	30560-6

PRO BRUSHES

"PRO TRADESMAN" Solid Round Tapered Polyester



6015



Size	Trim Length	Thickness	Pack/Box	UPC: 740962-
2"	2-3/4"	9/16"	12	30422-7
2-1/2"	3"	5/8"	12	30423-4
3"	3-1/4"	11/16"	12	30424-1

6025



Size	Trim Length	Thickness	Pack/Box	UPC: 740962-
2"	2-3/4"	9/16"	12	30425-8
2-1/2"	3"	5/8"	12	30426-5
3"	3-1/4"	11/16"	12	30427-2

6056



Size	Trim Length	Thickness	Pack/Box	UPC: 740962-
3"	3-1/2"	7/8"	6	30428-9

AW A1152

PRO TRADESMAN SPECIAL VALUE PACK

Each package contains one of each of the following brushes.

24 Packs Per Box

UPC
74096230510-1



1"	Flat Varnish Handle
1-1/2"	Angular Varnish Handles
2"	Angular Sash



Polyester Blend

6030 Flat Varnish



- Chisel Trim
- Lacquered Purple Tip Handle

Size	Trim Length	Thickness	Pack/Box	UPC: 740962-
1"	2-1/8"	7/16"	12	30243-8
1-1/2"	2-3/8"	1/2"	12	30121-9
2"	2-3/8"	9/16"	12	30122-6
2-1/2"	2-5/8"	5/8"	12	30123-3
3"	2-5/8"	11/16"	12	30124-0
4"	3-1/8"	11/16"	12	30180-6

6032 Flat Sash



- Chisel Trim
- Lacquered Purple Tip Handle

Size	Trim Length	Thickness	Pack/Box	UPC: 740962-
1"	2-1/8"	7/16"	12	30244-5
1-1/2"	2-3/8"	1/2"	12	30125-7
2"	2-3/8"	9/16"	12	30126-4
2-1/2"	2-5/8"	5/8"	12	30127-1
3"	2-5/8"	11/16"	12	30128-8

6022 Angular Sash



- Chisel Trim
- Lacquered Purple Tip Handle

Size	Trim Length	Thickness	Pack/Box	UPC: 740962-
1"	2-1/8"	7/16"	12	30242-1
1-1/2"	2-3/8"	1/2"	12	30117-2
2"	2-3/8"	9/16"	12	30118-9
2-1/2"	2-5/8"	5/8"	12	30119-6
3"	2-5/8"	11/16"	12	30120-1

Black China Bristle

5030 Flat Varnish



- Chisel Trim
- Lacquered Red Tip Handle

Size	Trim Length	Thickness	Pack/Box	UPC: 740962-
1"	2-1/8"	7/16"	12	30239-1
1-1/2"	2-3/8"	1/2"	12	30109-7
2"	2-3/8"	9/16"	12	30110-3
2-1/2"	2-5/8"	5/8"	12	30111-0
3"	2-5/8"	11/16"	12	30112-7
4"	3-1/8"	11/16"	12	30181-3

5022 Angular Sash



- Chisel Trim
- Lacquered Red Tip Handle

Size	Trim Length	Thickness	Pack/Box	UPC: 740962-
1"	2-1/8"	7/16"	12	30238-4
1-1/2"	2-3/8"	1/2"	12	30105-9
2"	2-3/8"	9/16"	12	30106-6
2-1/2"	2-5/8"	5/8"	12	30107-3
3"	2-5/8"	11/16"	12	30108-0

5032 Flat Sash



- Chisel Trim
- Lacquered Red Tip Handle

Size	Trim Length	Thickness	Pack/Box	UPC: 740962-
1"	2-1/8"	7/16"	12	30240-7
1-1/2"	2-3/8"	1/2"	12	30113-4
2"	2-3/8"	9/16"	12	30114-1
2-1/2"	2-5/8"	5/8"	12	30115-8
3"	2-5/8"	11/16"	12	30116-5

White China Bristle

5020 Angular Varnish



- Chisel Trim
- Lacquered Blue Tip Handle

Size	Trim Length	Thickness	Pack/Box	UPC: 740962-
1"	2-1/8"	7/16"	12	30237-7
1-1/2"	2-3/8"	1/2"	12	30101-1
2"	2-3/8"	9/16"	12	30102-8
2-1/2"	2-5/8"	5/8"	12	30103-5
3"	2-5/8"	11/16"	12	30104-2

5025 Angular Sash



- Chisel Trim
- Lacquered Blue Tip Handle

Size	Trim Length	Thickness	Pack/Box	UPC: 740962-
1"	2-1/8"	7/16"	12	30274-2
1-1/2"	2-3/8"	1/2"	12	30275-9
2"	2-3/8"	9/16"	12	30276-6
2-1/2"	2-5/8"	5/8"	12	30277-3
3"	2-5/8"	11/16"	12	30278-0

5035 Flat Varnish



- Chisel Trim
- Lacquered Blue Tip Handle

Size	Trim Length	Thickness	Pack/Box	UPC: 740962-
1"	2-1/8"	7/16"	12	30241-4
1-1/2"	2-3/8"	1/2"	12	30175-2
2"	2-3/8"	9/16"	12	30176-9
2-1/2"	2-5/8"	5/8"	12	30177-6
3"	3-1/8"	11/16"	12	30178-3
4"	3-5/8"	11/16"	12	30179-0

PAINT MATE

White China Bristle

9030 Varnish



- Chisel Trim
- Satin Finish Handle

Size	Trim Length	Thickness	Pack/Box	UPC: 740962-
1"	2-3/8"	7/16"	12	30301-5
1-1/2"	2-3/8"	1/2"	12	30302-2
2"	2-3/8"	9/16"	12	30303-9
2-1/2"	2-5/8"	5/8"	12	30304-6
3"	2-7/8"	11/16"	12	30305-3
4"	3-3/8"	11/16"	12	30311-4

9020 Angled Sash



- Chisel Trim
- Satin Finish Handle

Size	Trim Length	Thickness	Pack/Box	UPC: 740962-
1-1/2"	2-1/8"	1/2"	12	30307-7
2"	2-3/8"	9/16"	12	30308-4
2-1/2"	2-5/8"	5/8"	12	30309-1

PAINT MATE

Polyester Blend



7020 Angled Sash



- Chisel Trim
- Satin Finish Handle

Size	Trim Length	Thickness	Pack/Box	UPC: 740962-
1-1/2"	2-3/8"	1/2"	12	30297-1
2"	2-5/8"	9/16"	12	30298-8
2-1/2"	2-5/8"	5/8"	12	30299-5

7030 Varnish



- Chisel Trim
- Satin Finish Handle

Size	Trim Length	Thickness	Pack/Box	UPC: 740962-
1	2-3/8"	7/16"	12	30290-2
1-1/2"	2-3/8"	1/2"	12	30291-9
2"	2-3/8"	9/16"	12	30292-6
2-1/2"	2-5/8"	5/8"	12	30293-3
3"	2-7/8"	11/16"	12	30294-0
4"	3-3/8"	11/16"	12	30295-7

PROMOTIONAL BRUSHES



1500 Chip-White China Bristle



- Flat Trim
- Natural Wood Handle

Size	Trim Length	Thickness	Pack/Box	UPC: 077089-
1/2"	1-1/2"	1/4"	36	15000-1
1"	1-1/2"	5/16"	36	15001-8
1-1/2"	1-1/2"	5/16"	36	15002-5
2"	1-1/2"	5/16"	24	15003-2
2-1/2"	1-1/2"	3/8"	12	15004-9
3"	1-1/2"	3/8"	12	15005-6
4"	2"	11/16"	12	15007-0

1100 Chip-Polyester



- Flat Trim
- Solid Plastic Handle

Size	Trim Length	Thickness	Pack/Box	UPC: 077089-
1/2"	1-3/4"	5/16"	36	11000-5
1"	1-3/4"	5/16"	36	11001-2
1-1/2"	1-3/4"	5/16"	36	11002-9
2"	1-3/4"	5/16"	24	11003-6
2-1/2"	1-3/4"	5/16"	12	11004-3
3"	1-11/16"	5/16"	12	11005-0
#3170 4"	2-3/4"	11/16"	12	31707-7

1610 Bristle Varnish



- Chisel Trim
- Walnut Wood Handle

Size	Trim Length	Thickness	Pack/Box	UPC: 077089-
1"	2"	5/16"	12	16101-4
1-1/2"	2"	5/16"	12	16102-1
2"	2"	1/2"	12	16103-8
2-1/2"	2-1/4"	1/2"	12	16104-5
3"	2-1/2"	1/2"	12	16105-2
4"	2-1/2"	1/2"	12	16107-6

1550 Double Thick Chip



- Flat Trim
- Natural Wood Handle

Size	Trim Length	Thickness	Pack/Box	UPC: 077089-
1"	1-3/4"	7/16"	24	15501-3
1-1/2"	1-3/4"	1/2"	24	15502-0
2"	2"	9/16"	24	15503-7
2-1/2"	2"	5/8"	12	15504-4
3"	2"	11/16"	12	15505-1
4"	2-1/4"	11/16"	12	15507-5

BRUSHES

Bristlex® Stainer Brushes

1095 Olympian-Oil Stainer



Size	Trim Length	Thickness	Pack/Box	UPC: 740962-
3"	3"	1-1/2"	6	30288-9
4"	3-1/8"	1-1/2"	6	30250-6
5"	3-1/8"	1-1/2"	6	30251-3
6"	3-1/8"	1-1/2"	6	30252-0

- Flat Trim
- Threaded Grip Handle
- Nickel Ferrule

Polyester Blend Stainer Brushes

7095 Olympian™-Stainer Brush



Size	Trim Length	Thickness	Pack/Box	UPC: 740962-
3"	3"	1-1/2"	6	30289-6
4"	3-1/8"	1-1/2"	6	30253-7
5"	3-1/8"	1-1/2"	6	30254-4
6"	3-1/8"	1-1/2"	6	30255-1

- Flat Trim
- Threaded Grip Handle
- Nickel Ferrule

Super Stainer Bristlex®

1090 Stain Brush



Size	Trim Length	Thickness	Pack/Box	UPC: 740962-
4"	3-1/8"	7/8"	6	30039-7

- Chisel Trim
- Natural Wood Handle
- Stainless Ferrule

Super Stainer 100% Polyester

4090 Stain Brush



Size	Trim Length	Thickness	Pack/Box	UPC: 740962-
4"	3"	7/8"	6	30137-0

- Chisel Trim
- Natural Wood Handle
- Stainless Ferrule

Stainers

4080 100% Polyester

1080 100% China Bristle



Part #	Size	Trim Length	Thickness	Pack/Box	UPC: 740962-
4080	4"	3"	7/8"	6	30479-1
Part #	Size	Trim Length	Thickness	Pack/Box	UPC: 740962-
1080	4"	3"	7/8"	6	30478-4

- Chisel Trim
- Natural Wood Handle
- Stainless Ferrule

PROMOTIONAL BRUSHES



Foam

8505



- Wood Peg Handle

Size	Pack/Box	UPC: 077089-
1"	30	85051-2
2"	30	85053-6
3"	30	85055-0
4"	30	85057-4

BENT RADIATOR PROFESSIONAL

China Bristle

1070



- Chisel Trim
- 18" Bent Wood Handle

Size	Trim Length	Thickness	Pack/Box	UPC: 740962-
2"	2-1/2"	9/16"	12	30170-7
2-1/2"	2-3/4"	5/8"	12	30034-2
3"	3"	11/16"	12	30035-9

Polyester/Nylon

2070



- Solid Round Filament
- Form Chisel
- 18" Bent Wood Handle

Size	Trim Length	Thickness	Pack/Box	UPC: 740962-
2"	2-3/4"	9/16"	12	30189-9
2-1/2"	3"	5/8"	12	30067-0
3"	3-1/4"	11/16"	12	30068-7

China Bristle

2669



- Flat Trim
- 18" Bent Wood Handle

Size	Trim Length	Thickness	Pack/Box	UPC: 077089-
2"	2-1/2"	9/16"	12	26693-1
2-1/2"	2-1/2"	5/8"	12	26694-8
3"	2-3/4"	11/16"	12	26695-5

HOCKEY BRUSHES

Bristle

1078



- Chisel Tip
- 24" Hockey Wood Handle

Size	Trim Length	Thickness	Pack/Box	UPC: 740962-
3"	3"	11/16"	12	30160-5

Polyester/Nylon

2078



- Solid Round Filament
- Form Chisel Tip
- 24" Hockey Wood Handle

Size	Trim Length	Thickness	Pack/Box	UPC: 740962-
3"	3-1/4"	11/16"	12	30160-8

Tiny Trim 2888 Polyester/Nylon



- Form Chisel
- Seamless Steel
- Natural Wood Handle

Size	Trim Length	Thickness	Pack/Box	UPC: 077089-
2"	2-1/2"	9/16"	24	28883-4

The Right Brush TRB 4020



DISPLAY BOX

Tomorrow's Paint Brush

Size	Trim Length	Thickness	Pack/Box	UPC: 740962-
2-1/2"	3"	5/8"	6	2305323
2-1/2"	3"	5/8"	12	2305408

Stencil 6650 Black China Bristle



- Flat Trim
- Seamless Steel Ferrule
- Lacquered Wood Handle

Size	Trim Length	Thickness	Pack/Box	UPC: 077089-
#4	1-1/4"	3/4"	12	66502-4
#6	1-3/8"	1"	12	66503-1
#8	1-1/2"	1-1/4"	12	66504-8
#10	1-5/8"	1-1/2"	12	66505-5

Parts Cleaning 6350



- Chisel Trim
- Seamless Steel Ferrule
- Round Plastic Handle

Size	Trim Length	Thickness	Pack/Box	UPC: 077089-
#8	2-3/4"	15/16"	12	63540-1
#10	2-7/8"	1-1/16"	12	63505-8

Oval Sash 2651 Black China Bristle



- Chisel Trim
- Seamless Steel Ferrule
- Round Plastic Handle

Size	Trim Length	Thickness	Pack/Box	UPC: 077089-
#2	1-3/4"	1/2"	24	26511-8
#4	2"	3/4"	12	26512-5
#6	2-1/4"	7/8"	12	26513-2
#8	2-1/4"	1"	12	26514-9
#10	2-1/2"	1-1/8"	12	26515-6
#12	2-3/4"	1-3/8"	12	26516-3

Masonry Roof 607

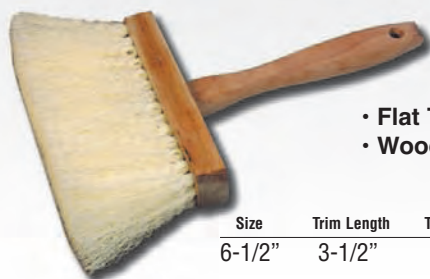

- Flat Trim
- Wood Handle

Size	Trim Length	Thickness	Pack/Box	UPC: 077089-
6-1/2"	3-1/2"	1-5/8"	12	60700-0 15

Scrub & Acid 407



- Flat Trim
- Wood Block

Size	Trim Length	Pack/Box	UPC: 077089-
8"	1"	12	40700-6

PROJECT SELECT BRUSH SETS



2 Piece Brush Set



A154S

100% Polyester

3 Piece Brush Set



A225

100% Polyester

4 Piece Brush Set



A2204

100% Polyester

A154S

Sizes	Trim Length	Pack/Box	UPC: 077089-
1-1/2"	2-1/4"	12	15400-9
4"	3-1/2"	12	15400-9

A225

Sizes	Trim Length	Pack/Box	UPC: 077089-
1-1/2"	2-1/4"	12	22500-6
2"	2-1/2"	12	22500-6
3"	3-1/4"	12	22500-6

A2204

Sizes	Trim Length	Pack/Box	UPC: 077089-
1"	2-1/4"	24	22040-7
2"	2-3/4"	24	22040-7
3"	3-1/4"	24	22040-7
4"	4"	24	22040-7

BRUSHES

ARTIST BRUSHES



A333

3 Piece Red Sable brush set, carded. Round #1, #2, #3

Code Number	Size Number	Packed Per Ctn	UPC 077089-
A333	LJ300	12	33300-8



A444

4 Piece Red Sable brush set, carded. Round #1, #4, Flat #4, #8

Code Number	Size Number	Packed Per Ctn	UPC 077089-
A444	LJ200	12	44400-1



A555

5 Piece pony hair brush set, carded. 5 assorted brushes

Code Number	Size Number	Packed Per Ctn	UPC 077089-
A555	LJ900	12	55500-4

9300



• Flat Black Bristle Carded • Painted Wood Handle

Code Number	Size Number	Trim Length	Qty Per Pack	Packed Per Ctn	UPC 077089-
9300	#2	5/16"	6	12	93002-3
9300	#4	5/16"	6	12	93004-7
9300	#6	3/8"	6	12	93006-1

9301



• Flat Black Bristle Carded • Painted Wood Handle

9301	#3	11/16"	6	12	93013-9
9301	#5	7/8"	6	12	93015-3
9301	#7	1-1/8"	6	12	93017-7

9302



• Flat Black Bristle Carded • Painted Wood Handle

9302	#2	7/16"	6	12	93022-1
9302	#4	1/2"	6	12	93024-5
9302	#6	5/8"	6	12	93026-9

9303



• Flat Black Bristle Carded • Painted Wood Handle

9303	#1	3/8"	6	12	93031-3
9303	#3	7/16"	6	12	93033-7
9303	#5	1/2"	6	12	93035-1

9304

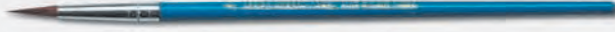

• Flat Black Bristle Carded • Painted Wood Handle

9304	#2	3/8"	6	12	93042-9
9304	#4	1/2"	6	12	93044-3
9304	#6	3/4"	6	12	93046-7

9305



• Flat Black Bristle Carded • Painted Wood Handle

9305	1/4"	1/2"	6	12	93051-1
9305	1/2"	11/16"	6	12	93053-5
9305	3/4"	15/16"	6	12	93056-6

100% Merino Lambskin-AAA

100% Natural Lambskin

Phenolic Core

SMOOTH TO SEMI-SMOOTH

Code Number	Nap Height	Length	Packed Per Ctn	UPC 740963-
9FL3	3/8"	9"	50	10461-1

SEMI-SMOOTH TO SEMI-ROUGH

Code Number	Nap Height	Length	Packed Per Ctn	UPC 740963-
7FL4	1/2"	7"	50	10082-8
9FL4	1/2"	9"	50	10083-5
7FL6	3/4"	7"	50	10085-9
9FL6	3/4"	9"	50	10086-6
9FL8	1"	9"	40	10197-9



ROUGH SURFACE

Code Number	Nap Height	Length	Packed Per Ctn	UPC 740963-
9FL10	1-1/4"	9"	40	10089-7
9FL12	1-1/2"	9"	40	10237-9

Viodel Purple

Finest AAA Quality synthetic material including nylon and acrylic as well as polyester fibers. Good for all paints. Solvent resistant core (SRC).

SMOOTH TO SEMI-SMOOTH

Code Number	Nap Height	Length	Packed Per Ctn	UPC 740963-
7FV3	3/8"	7"	50	10023-1
9FV3	3/8"	9"	50	10024-8

SEMI-SMOOTH TO SEMI-ROUGH

Code Number	Nap Height	Length	Packed Per Ctn	UPC 740963-
7FV4	1/2"	7"	50	10027-9
9FV4	1/2"	9"	50	10028-6
7FV6	3/4"	7"	50	10031-6
9FV6	3/4"	9"	50	10032-3



ROUGH SURFACE

Code Number	Nap Height	Length	Packed Per Ctn	UPC 740963-
9FV10	1-1/4"	9"	40	10227-3

MICROFIBER

A Special Blend of High Capacity Non-Shedding European Woven Fabric Good for All Paints & Stains, especially New Low VOC Coatings.

SMOOTH TO SEMI-SMOOTH

Code Number	Nap Height	Length	Packed Per Ctn	UPC 740963-
7MFR2	1/4"	7"	25	11104-6
9MFR2	1/4"	9"	25	11092-6
18MFR2	1/4"	18"	12	11116-9
18CCMFR2	1/4"	18"	12	11118-3

SEMI-SMOOTH TO SEMI-ROUGH

Code Number	Nap Height	Length	Packed Per Ctn	UPC 740963-
7MFR3	3/8"	7"	25	11105-3
9MFR3	3/8"	9"	25	11093-3
18MFR3	3/8"	18"	12	11100-8
18CCMFR3	3/8"	18"	12	11101-5



Code Number	Nap Height	Length	Packed Per Ctn	UPC 740963-
7MFR4	9/16"	7"	25	11106-0
9MFR4	9/16"	9"	25	11094-0
18MFR4	9/16"	18"	12	11102-2
18CCMFR4	9/16"	18"	12	11103-9

Glossdel-White Lintless

A deluxe non-shedding, woven lintless synthetic fabric designed for use with high gloss, semi-gloss, and eggshell finish paints. Good for all alkyd/oil paints. Solvent resistant core (SRC).

SMOOTH

Code Number	Nap Height	Length	Packed Per Ctn	UPC 740963-
3FGL2	1/4"	3"	50	10065-1
4FGL2	1/4"	4"	50	10066-8
7FGL2	1/4"	7"	50	10067-5
9FGL2	1/4"	9"	50	10068-2

SMOOTH TO SEMI-SMOOTH

Code Number	Nap Height	Length	Packed Per Ctn	UPC 740963-
3FGL3	3/8"	3"	50	10069-9
4FGL3	3/8"	4"	50	10070-5
7FGL3	3/8"	7"	50	10071-2
9FGL3	3/8"	9"	50	10072-9
18FGL3	3/8"	18"	25	10198-6



SEMI-SMOOTH TO SEMI-ROUGH

Code Number	Nap Height	Length	Packed Per Ctn	UPC 740963-
3FGL4	1/2"	3"	50	10073-6
4FGL4	1/2"	4"	50	10074-3
7FGL4	1/2"	7"	50	10075-0
9FGL4	1/2"	9"	50	10076-7
18FGL4	1/2"	18"	25	10383-6

SEMI-ROUGH TO ROUGH

Code Number	Nap Height	Length	Packed Per Ctn	UPC 740963-
3FGL6	3/4"	3"	50	10077-4
4FGL6	3/4"	4"	50	10078-1
7FGL6	3/4"	7"	50	10079-8
9FGL6	3/4"	9"	50	10080-4

ROLLER COVERS

PRO-LINE PROFESSIONAL ROLLERS



Lamdel-Maize

A deluxe, medium density, polyester blend. Good for all paints. Solvent resistant core (SRC).

SMOOTH				
Code Number	Nap Height	Length	Packed Per Ctn	UPC 740963-
3FLD2	1/4"	3"	50	10400-0
4FLD2	1/4"	4"	50	10401-7
7FLD2	1/4"	7"	50	10253-2
9FLD2	1/4"	9"	50	10252-5

SMOOTH TO SEMI-SMOOTH				
Code Number	Nap Height	Length	Packed Per Ctn	UPC 740963-
3FLD3	3/8"	3"	50	10049-1
4FLD3	3/8"	4"	50	10050-7
7FLD3	3/8"	7"	50	10051-4
9FLD3	3/8"	9"	50	10052-1

SEMI-SMOOTH TO ROUGH				
Code Number	Nap Height	Length	Packed Per Ctn	UPC 740963-
3FLD4	1/2"	3"	50	10053-8
4FLD4	1/2"	4"	50	10054-5
7FLD4	1/2"	7"	50	10055-2
9FLD4	1/2"	9"	50	10056-9
18FLD4	1/2"	18"	25	10199-3
3FLD6	3/4"	3"	50	10057-6
4FLD6	3/4"	4"	50	10058-3
7FLD6	3/4"	7"	50	10059-0
9FLD6	3/4"	9"	50	10060-6



ROUGH SURFACE

Code Number	Nap Height	Length	Packed Per Ctn	UPC 740963-
4FLD10	1-1/4"	4"	40	10062-0
7FLD10	1-1/4"	7"	40	10063-7
9FLD10	1-1/4"	9"	40	10064-4

Prodel Blue

A deluxe, medium density, highly resilient, polyester synthetic fabric. Good for all paints. Solvent resistant core (SRC).

SMOOTH TO SEMI-SMOOTH				
Code Number	Nap Height	Length	Packed Per Ctn	UPC 740963-
7FP3	3/8"	4"	50	10034-7
9FP3	3/8"	7"	50	10035-4
9FP3	3/8"	9"	50	10036-1

SEMI-SMOOTH TO SEMI-ROUGH				
Code Number	Nap Height	Length	Packed Per Ctn	UPC 740963-
4FP4	1/2"	4"	50	10038-5
7FP4	1/2"	7"	50	10039-2
9FP4	1/2"	9"	50	10040-8



SEMI-ROUGH TO ROUGH

Code Number	Nap Height	Length	Packed Per Ctn	UPC 740963-
4FP6	3/4"	4"	50	10042-2
7FP6	3/4"	7"	50	10043-9
9FP6	3/4"	9"	50	10044-6

ROUGH SURFACE

Code Number	Nap Height	Length	Packed Per Ctn	UPC 740963-
9FP10	1-1/4"	9"	40	10048-4

MERINO Sheepskin

Code Number	Nap Height	Length	Packed Per Ctn	UPC 814478-
738L	3/8"	7"	12	70038-2
938L	3/8"	7"	12	90038-6
1838L	3/8"	18"	12	18038-2

Code Number	Nap Height	Length	Packed Per Ctn	UPC 814478-
950L	1/2"	9"	12	90050-8
1450L	1/2"	14"	12	14050-8
1850L	1/2"	18"	12	18050-4
975L	3/4"	9"	12	90075-1
1475L	3/4"	14"	12	14075-1
1875L	3/4"	18"	12	18075-7
9100L	1"	9"	12	90100-0
18100L	1"	18"	12	18100-6
9125L	1-1/4"	9"	12	90125-3
18125L	1-1/4"	18"	12	18125-9
9150L	1-1/2"	9"	12	90150-5
18150L	1-1/2"	18"	12	18150-1

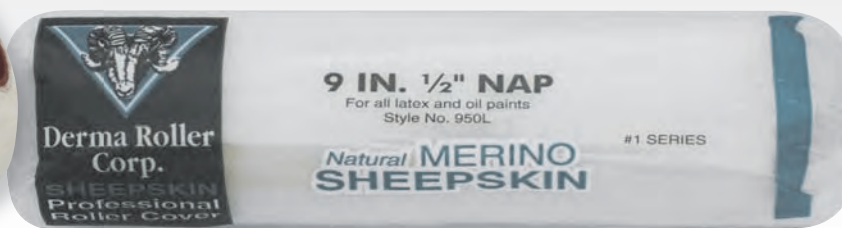

TRADESMAN



Tradesman-Orange

100% Polyester Good for all paints. Solvent resistant core (SRC).

SMOOTH TO SEMI ROUGH				
Code Number	Nap Height	Length	Packed Per Ctn	UPC 740963-
9DIY2	1/4"	9"	50	10004-0
3DIY3	3/8"	3"	50	10005-7
4DIY3	3/8"	4"	50	10006-4
7DIY3	3/8"	7"	50	10007-1
9DIY3	3/8"	9"	50	10008-8

SEMI ROUGH TO ROUGH				
Code Number	Nap Height	Length	Packed Per Ctn	UPC 740963-
4DIY4	1/2"	4"	15	10010-1
7DIY4	1/2"	7"	50	10011-8
9DIY4	1/2"	9"	50	10012-5



ROUGH TO VERY ROUGH

Code Number	Nap Height	Length	Packed Per Ctn	UPC 740963-
3DIY6	3/4"	3"	50	10013-2
4DIY6	3/4"	4"	50	10014-9
7DIY6	3/4"	7"	50	10015-6
9DIY6	3/4"	9"	50	10016-3

VERY ROUGH

Code Number	Nap Height	Length	Packed Per Ctn	UPC 740963-
9DIY10	1-1/4"	9"	40	10020-0

ROLLER COVERS

PAINT MATE



Paint Mate-Melon *100% Polyester* Good for all paints. Solvent resistant core (SRC).



SMOOTH TO SEMI ROUGH

Code Number	Nap Height	Length	Packed Per Ctn	UPC 740963-
3P3	3/8"	3"	50	10114-9
4P3	3/8"	4"	50	10115-6
7P3	3/8"	7"	50	10116-3
9P3	3/8"	9"	50	10117-7

SEMI ROUGH TO ROUGH

Code Number	Nap Height	Length	Packed Per Ctn	UPC 740963-
7P4	1/2"	7"	50	10120-7
9P4	1/2"	9"	50	10121-4

SPECIALTY ROLLERS



ROLLER COVERS

Mohair-Red

SYNTHETIC PAINT TYPE ROLLER
Good for all paints. Solvent resistant core (SRC).



SMOOTH

Code Number	Nap Height	Length	Packed Per Ctn	UPC 740963-
3PBM	3/16"	3"	50	10110-8
4PBM	3/16"	4"	50	10111-5
7PBM	3/16"	7"	50	10112-2
9PBM	3/16"	9"	50	10113-9

Texture Goop *RC117*

Texture plastic loop construction for all texture, stipple and sand paints.
Solvent resistant core (SRC).



SMOOTH

Code Number	Nap Height	Length	Packed Per Ctn	UPC 077089-
RC117	1/4"	9"	50	11712-9

Stipple Brown *RC116*

Stipple carpet fabric produces a design on smooth walls.
Phenolic core.

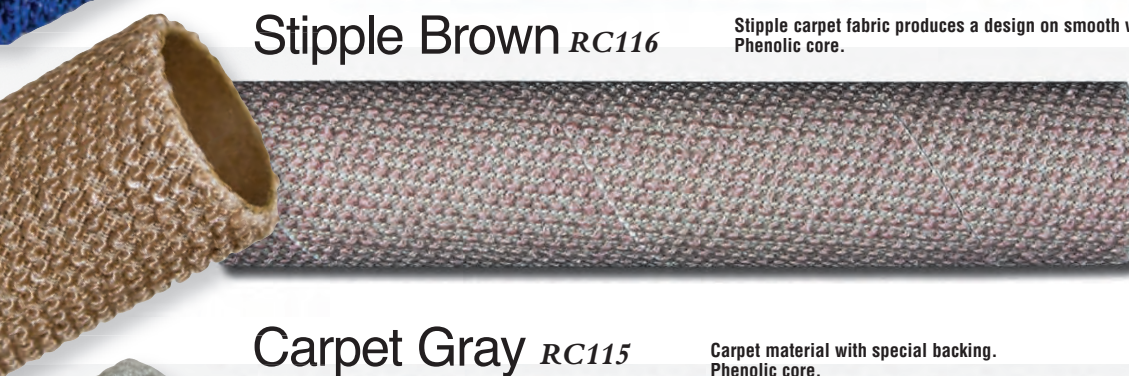

SMOOTH

Code Number	Nap Height	Length	Packed Per Ctn	UPC 077089-
RC116	1/16"	7"	50	11610-6
RC116	1/16"	9"	50	11612-0

Carpet Gray *RC115*

Carpet material with special backing.
Phenolic core.



SMOOTH

Code Number	Nap Height	Length	Packed Per Ctn	UPC 077089-
RC115	1/4"	9"	50	11512-3

Viodel-Purple

Finest AAA Quality synthetic material including nylon and acrylic as well as polyester fibers. Good for all paints.
Closed, High Solvent Resistant Core

SEMI-SMOOTH TO SEMI-ROUGH

Code Number	Nap Height	Length	Packed Per Ctn	UPC 740963-
18CCV4	1/2"	18"	25	10244-0

SEMI-ROUGH TO ROUGH

Code Number	Nap Height	Length	Packed Per Ctn	UPC 740963-
18CCV6	3/4"	18"	25	10242-6

Special Order Custom Nap Sizes are Available! Call for Details!



MICROFIBER

A Special Blend of High Capacity Non-Shedding European Woven Fabric Good for All Paints & Stains, especially New Low VOC Coatings.
Closed, High Solvent Resistant Core

SEMI-SMOOTH TO ROUGH

Code Number	Nap Height	Length	Packed Per Ctn	UPC 740963-
18MFR2	1/4"	18"	12	11116-9
18CCMFR2	1/4"	18"	12	11118-3

SEMI-ROUGH TO ROUGH

Code Number	Nap Height	Length	Packed Per Ctn	UPC 740963-
18MFR3	3/8"	18"	12	11100-8
18CCMFR3	3/8"	18"	12	11101-5
18MFR4	9/16"	18"	12	11102-2
18CCMFR4	9/16"	18"	12	11103-9

Special Order Custom Nap Sizes are Available! Call for Details!



Glossdel-White

A deluxe medium density highly resilient polyester synthetic fabric. Good for all paints. Closed, high solvent resistant core (SRC).
Closed, High Solvent Resistant Core

SMOOTH TO SEMI-SMOOTH

Code Number	Nap Height	Length	Packed Per Ctn	UPC 740963-
18CCGL3	3/8"	18"	25	10361-4

SEMI-SMOOTH TO SEMI-ROUGH

Code Number	Nap Height	Length	Packed Per Ctn	UPC 740963-
18CCGL4	1/2"	18"	25	10362-1

Special Order Custom Nap Sizes are Available! Call for Details!



Lamdel-Maize

A deluxe, medium density, polyester blend. Good for all paints. Closed, high solvent resistant core (SRC).
Closed, High Solvent Resistant Core

SMOOTH TO SEMI-SMOOTH

Code Number	Nap Height	Length	Packed Per Ctn	UPC 740963-
18CCLD3	3/8"	18"	25	10373-7

SEMI-SMOOTH TO SEMI-ROUGH

Code Number	Nap Height	Length	Packed Per Ctn	UPC 740963-
18CCLD4	1/2"	18"	25	10211-2

SEMI-ROUGH TO ROUGH

Code Number	Nap Height	Length	Packed Per Ctn	UPC 740963-
18CCLD6	3/4"	18"	25	10208-2

Special Order Custom Nap Sizes are Available! Call for Details!



Prodel-Blue

A deluxe, medium density, highly resilient, polyester synthetic fabric. Good for all paints. Closed, high solvent resistant core (SRC).
Closed, High Solvent Resistant Core

SMOOTH TO SEMI-SMOOTH

Code Number	Nap Height	Length	Packed Per Ctn	UPC 740963-
4CCP3	3/8"	4"	50	10500-7
7CCP3	3/8"	7"	50	10501-4
9CCP3	3/8"	9"	50	10348-5
18CCP3	3/8"	18"	25	10206-8

SEMI-SMOOTH TO SEMI-ROUGH

Code Number	Nap Height	Length	Packed Per Ctn	UPC 740963-
4CCP4	1/2"	4"	50	10502-1
7CCP4	1/2"	7"	50	10503-8
9CCP4	1/2"	9"	50	10349-2
14CCP4	1/2"	14"	25	10338-6
18CCP4	1/2"	18"	25	10235-8

SEMI-ROUGH TO ROUGH

Code Number	Nap Height	Length	Packed Per Ctn	UPC 740963-
4CCP6	3/4"	4"	50	10456-7
7CCP6	3/4"	7"	50	10457-4
9CCP6	3/4"	9"	50	10350-8
18CCP6	3/4"	18"	25	10234-1

Special Order Custom Nap Sizes are Available! Call for Details!



SPECIALTY ROLLERS



Foam Yellow

Foam Roller Covers PVC Core.



SMOOTH

Code Number	Nap Height	Length	Packed Per Ctn	UPC 740963-
7PFME	3/16"	7"	50	10100-9
9PFME	3/16"	9"	50	10101-6

SEMI-SMOOTH

Code Number	Nap Height	Length	Packed Per Ctn	UPC 740963-
7PFM	3/8"	7"	50	10096-5
9PFM	3/8"	9"	50	10097-2

Foam Twin Packs

Foam Roller Covers



SMOOTH

Code Number	Nap Height	Length	Packed Per Ctn	UPC 740963-
7PFME-T/P	3/16"	7"	36	10910-4
9PFME-T/P	3/16"	9"	36	10919-7

Slit Foam Yellow

RC180 Foam Roller Covers

PVC Core.



Resilient hollow core slit foam roller covers are great for use on acoustical ceilings, concrete and block walls. Use with all paints*.

***Not for use with shellac and lacquers.**

SEMI-SMOOTH

Code Number	Nap Height	Length	Packed Per Ctn	UPC 077089-
RC180	1/2"	9"	12	18012-1

Slit Foam Yellow

RC181 Foam Roller Covers

PVC Core.



ROUGH SURFACE

Code Number	Nap Height	Length	Packed Per Ctn	UPC 077089-
RC181	13/16"	9"	12	18112-8

9" Foam Yellow 3-Pack

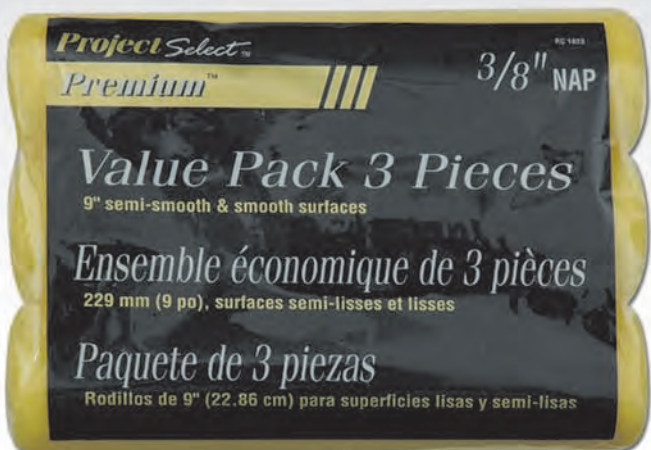

9" White Foam Cover



Semi-Smooth Single

Code Number	Size	Nap Size	Packed Per Ctn	UPC 077089-
RC182	9"	3/8"	12	18212-5

Semi-Smooth 3-Pack

Code Number	Size	Nap Size	Packed Per Ctn	UPC 077089-
RC1823	9"	3/8"	12	18230-9

Super Smooth

Code Number	Size	Nap Size	Packed Per Ctn	UPC 077089-
RC200	9"	1/4"	12	02009-0

ROLLER COVERS

MULTI-PACKS ROLLER COVERS



Glossdel White Multi Packs-Lintless

A deluxe non-shedding, woven lintless synthetic fabric designed for use with high gloss, semi-gloss, and eggshell finish paints. Good for all alkyd/oil paints. Solvent resistant core (SRC).

SMOOTH TO SEMI-SMOOTH

Code Number	Qty Per Pack	Nap Height	Length	Packed Per Ctn	UPC
9FLG3-4PK	4	3/8"	9"	12	10738-4



Lamdel Multi Packs

High performance synthetic roller covers Good for all paints. Solvent resistant core (SRC).

SMOOTH TO SEMI-SMOOTH

Code Number	Qty Per Pack	Nap Height	Length	Packed Per Ctn	UPC
9FLD4-4PK	4	1/2"	9"	12	11002-5



Economy Tri-Packs RC134

SMOOTH TO SEMI-SMOOTH

Code Number	Qty Per Pack	Nap Height	Length	Packed Per Ctn	UPC
RC134	3	3/8"	9"	24	13412-4



Paint Mate Melon 2, 3 & 6 Packs 100% Polyester

SMOOTH TO SEMI-SMOOTH

Code Number	Qty Per Pack	Nap Height	Length	Packed Per Ctn	UPC
4P3-T/P	2	3/8"	4"	36	10623-3
9P3-T/P	2	3/8"	9"	36	10625-7
9P3-3/P	3	3/8"	9"	32	10655-4
9P3-6/P	6	3/8"	9"	12	10627-1



Economy 4-Packs RC135

SMOOTH TO SEMI-SMOOTH

Code Number	Qty Per Pack	Nap Height	Length	Packed Per Ctn	UPC
RC135	4	3/8"	9"	12	13512-1



Economy 6-Packs RC139

SMOOTH TO SEMI-SMOOTH

Code Number	Qty Per Pack	Nap Height	Length	Packed Per Ctn	UPC
RC139	6	3/8"	9"	12	13912-9

ROLLER COVERS

EXTENSION POLES

Pro-Line Deluxe Wood Poles

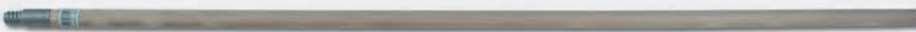

3-Piece Pole Set



Pro Locking Push Button Release Fiberglass and aluminum



Pro Extender Twist To Lock

Fiberglass and aluminum. Twist to lock, twist to release



Twist 2 Extend All Aluminum

Aluminum. Twist to open, twist to close.



Wood Poles, Threaded Metal Tip

Code Number	Size	Packed Per Ctn	UPC
RP548HM	48"	25	54801-3
RP560HM	60"	25	56001-5
RP573HM	72"	25	57301-5

3-Piece Set

RP503	12" Each	12	50313-5
-------	----------	----	---------

Push Button Pro Extender

RP2448	2'-4"	6	24480-9
RP3672	3'-6"	6	36720-1
RP4896	4'-8"	6	48960-6
RP72144	6'-12"	6	72144-7
RP96192	8'-16"	6	96192-8

Twist To Lock Pro Extender

RP204	2'-4"	6	20401-8
RP408	4'-8"	6	40801-0
RP612	6'-12"	6	612011
RP816	8'-16"	6	81601-3
RP824	12'-24"	6	82401-8

Twist 2 Extend

RP603	3'-6"	12	03060-0
RP804	4'-8"	12	04080-7
RP126	6'-12"	12	06120-8

Golden Eagle

Our Best Hollow Core
Roller Frame
5/16" Shank



Top of the Line

- Nylon End Caps • Heavy Duty Shank
- Nylon Bearings • Metal Ferrule on Grip

Code Number	Size	Shank Size	Cage Frame	Packed Per Ctn	UPC 740963-
3PHK5G	3"	5/16"	5-Wire	40	10957-9
4PHK5G	4"	5/16"	5-Wire	40	10644-8
7PHK5G	7"	5/16"	5-Wire	40	10128-3
9PHK5G	9"	5/16"	5-Wire	40	10127-6

White Condor Long Shank

5/16" Heavy Duty Shank

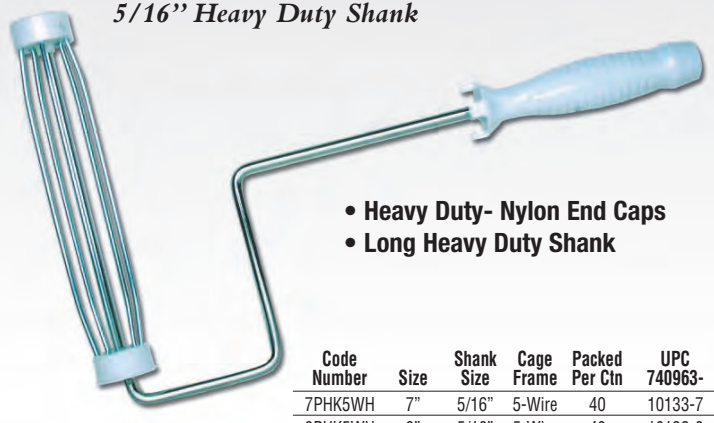

- Heavy Duty- Nylon End Caps
- Long Heavy Duty Shank

Code Number	Size	Shank Size	Cage Frame	Packed Per Ctn	UPC 740963-
7PHK5WH	7"	5/16"	5-Wire	40	10133-7
9PHK5WH	9"	5/16"	5-Wire	40	10132-0

Jumbo Frame

5/16" Shank

Heavy Duty- Nylon End Caps, Long Heavy Duty Shank, Metal Ferrule on Grip.

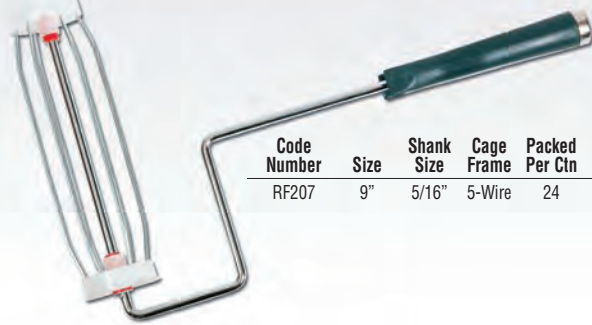

Code Number	Size	Shank Size	Cage Frame	Packed Per Ctn	UPC 077089-
RF207	9"	5/16"	5-Wire	24	20712-5

White Condor

5/16" Shank

Heavy Duty- Nylon End Caps, Short Heavy Duty Shank.

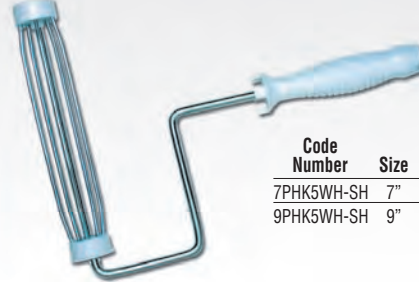

Code Number	Size	Shank Size	Cage Frame	Packed Per Ctn	UPC 740963-
7PHK5WH-SH	7"	5/16"	5-Wire	40	10353-9
9PHK5WH-SH	9"	5/16"	5-Wire	40	10354-6

5-Wire Cage, Wood Handle

5/16" Shank

Threaded Wood Grip
Wood Handle
Metal Ferrule



Code Number	Size	Shank Size	Cage Frame	Packed Per Ctn	UPC 077089-
RF209W	9"	5/16"	5-Wire	12	20900-6

5-Wire Cage

5/16" Shank

Threaded Plastic Grip
Metal Ferrule



Code Number	Size	Shank Size	Cage Frame	Packed Per Ctn	UPC 077089-
RF209	7"	5/16"	5-Wire	12	20910-5
RF209	9"	5/16"	5-Wire	12	20912-9
RF209	12"	5/16"	5-Wire	12	20913-6

5-Wire Cage

5/16" Shank

Threaded Plastic Grip Metal Ferrule

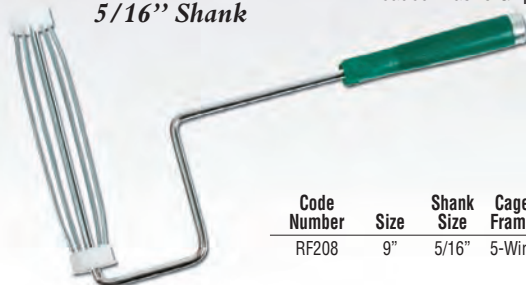

Code Number	Size	Shank Size	Cage Frame	Packed Per Ctn	UPC 077089-
RF208	9"	5/16"	5-Wire	24	20812-2

5-Wire Cage

1/4" Shank



Code Number	Size	Shank Size	Cage Frame	Packed Per Ctn	UPC 077089-
RF201	9"	1/4"	5-Wire	12	20112-3

ROLLER FRAMES



Tradesman

1/4" Shank

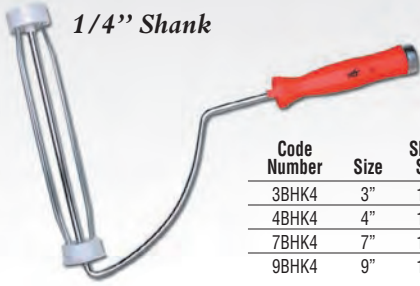

For the non-professional painter. They are functionally designed for use with all conventional latex and oil based paints and are manufactured under the strictest quality controls to the industry's finest tolerances.

Code Number	Size	Shank Size	Cage Frame	Packed Per Ctn	UPC 740963-
3BHK4	3"	1/4"	4-Wire	40	10138-2
4BHK4	4"	1/4"	4-Wire	40	10150-4
7BHK4	7"	1/4"	4-Wire	40	10151-1
9BHK4	9"	1/4"	4-Wire	40	10152-8

4-Wire Cage

1/4" Shank



Threaded Plastic Grip

Code Number	Size	Shank Size	Cage Frame	Packed Per Ctn	UPC 077089-
RF200	3"	1/4"	4-Wire	12	20005-8
RF200	4"	1/4"	4-Wire	12	20007-2
RF200	7"	1/4"	4-Wire	24	20010-2
RF200	9"	1/4"	4-Wire	24	20012-6

Twist 2 Extend™



Soft Comfort Grip
5-Wire Roller Cage
Twist to extend handle from 20-1/2" to 33" total length.

Code Number	Size	Shank Size	Cage Frame	Packed Per Ctn	UPC 077089-
RF300	9"	5/16"	5-Wire	12	30012-3

Professional Adjustable Roller Frame

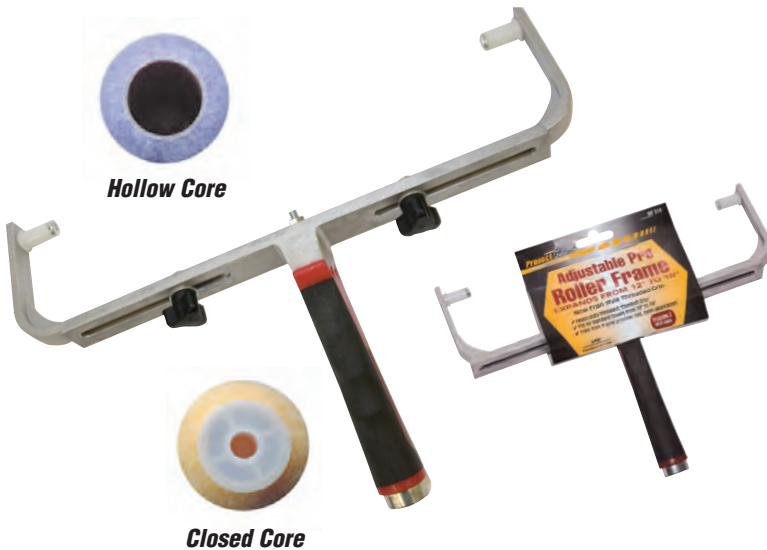

Hollow Core



Closed Core

End Caps



Code Number	Packed Per Ctn	UPC 740963-
18EC	24	10192-4

Adjustable from 12" TO 18". Professional roller frame comes with 2 end caps so it can be used with closed core covers or hollow core covers. These heavy duty frames are specially constructed of the highest quality materials. For use by professionals, contractors and the marine trade. Heavy duty threaded comfort grip. Yoke style frame provides fast, even application.

Code Number	Steel Shank	Size	Packed Per Ctn	UPC 077089-
RF210	-	12"-18"	6	21000-2

Closed Core Frames



Closed Core

Designed to be used with Arrowworthy's closed core covers, these heavy duty frames are specially constructed of the highest quality materials. For use by professionals, contractors and the marine trade.

Code Number	Steel Shank	Size	Packed Per Ctn	UPC 740963-
4PHR	5/16"	4"	50	10345-4
7PHR	5/16"	7"	50	10346-1
9PHR	5/16"	9"	50	10347-1

The DUO



We didn't invent the roller frame, we just improved it! Covers twice the area with just one dip of paint. Applies a double coat of paint at one time. Paints twice as fast as a single roller. Applies a smoother, cleaner paint finish.

Code Number	Steel Shank	Size	Packed Per Ctn	UPC 077089-
RF600	-	9"	6	00600-1

ROLLER FRAMES

PAINT ROLLER TRAYS



RM50 Plastic Roller Tray

Code Number	Use With Roller	Packed Per Ctn	UPC 077089-
RM50	4"	48	00050-4



4RWT-P Plastic Roller Tray

Code Number	Use With Roller	Packed Per Ctn	UPC 740963-
4RWT-P	4"	24	10485-7



RM403 Plastic Roller Tray
1 Quart

Code Number	Use With Roller	Ladder Grips	Tray Size	Packed Per Ctn	UPC 077089-	Use Liner
RM403	7"- 9"	Yes	1 QT	24	40322-1	RM410



BWT-P Plastic Roller Tray
2 Quart

Code Number	Use With Roller	Ladder Grips	Tray Size	Packed Per Ctn	UPC 740963-	Use Liner
BWT-P	7"- 9"	Yes	2 QT	12	10172-6	TL-LG



RM422 Plastic Roller Tray
2 Quart

Code Number	Use With Roller	Ladder Grips	Tray Size	Packed Per Ctn	UPC 077089-
RM422	7"- 9"	No	2 QT	50	42212-2



RM425 Plastic Roller Tray
4 Quart

Code Number	Use With Roller	Ladder Grips	Tray Size	Packed Per Ctn	UPC 077089-
RM425	7"- 9"	No	4 QT	12	42512-3



RM400 Metal Roller Tray
1 Quart

Code Number	Use With Roller	Ladder Grips	Tray Size	Packed Per Ctn	UPC 077089-	Use Liner
RM400	7"- 9"	Yes	1 QT	24	40012-0	RM410



RM430 Metal Roller Tray
2 Quart

Code Number	Use With Roller	Ladder Grips	Tray Size	Packed Per Ctn	UPC 077089-	Use Liner
RM430	7"- 9"	Yes	2 QT	10	43012-7	RM423



RM435 Metal Roller Tray
2 Quart

Code Number	Use With Roller	Ladder Grips	Tray Size	Packed Per Ctn	UPC 077089-	Use Liner
RM435	7"- 9"	Yes	2 QT	10	43512-2	RM412



RM505 Plastic Roller Tray
1 Quart
Heavy Duty Rugged Plastic Tray Strong Ladder Legs

Code Number	Use With Roller	Ladder Grips	Tray Size	Packed Per Ctn	UPC 077089-	Use Liner
RM505	7"-9"	Yes	1QT	12	50512-2	RM410



RM418 Plastic Roller Tray
Large Capacity

Code Number	Use With Roller	Packed Per Ctn	UPC 077089-
RM418	18"	12	41815-6



MHT Plastic Roller Tray
Large Capacity

Code Number	Use With Roller	Packed Per Ctn	UPC 740963-
MHT	18"	2	10177-1

ROLLER TRAY LINERS



RM410 Tray liner

Use With Tray

RM400
RM403



Code Number	Tray Size	Packed Per Ctn	UPC 077089-
RM410	1 QT	144	41012-9

RM423 Tray liner

Use With Tray

RM430
RM405



Code Number	Tray Size	Packed Per Ctn	UPC 077089-
RM423	2 QT	50	42300-6

RM412 Tray liner

Use With Tray

RM435

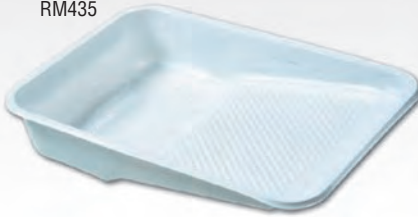

Code Number	Tray Size	Packed Per Ctn	UPC 077089-
RM412	1 GAL	72	41200-0

TL-LG Tray liner

Use With Tray

BWT-P



Code Number	Tray Size	Packed Per Ctn	UPC 740963-
TL-LG	2 QT	50	10288

ROLLER TRAY LINERS

BUCKET GRIDS



RM150 Bucket Grid

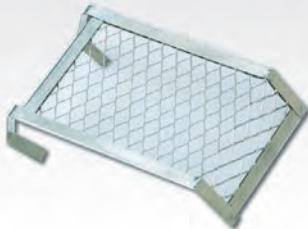

Code Number	Tray Size	Packed Per Ctn	UPC 077089-
RM150	1 GAL	12	01508-9

RM414 Bucket Grid



Code Number	Tray Size	Packed Per Ctn	UPC 077089-
RM414	2 GAL	12	41400-4

RM415 Bucket Grid

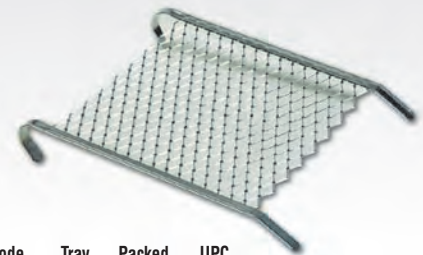

Code Number	Tray Size	Packed Per Ctn	UPC 077089-
RM415	5 GAL	12	41500-1

RM416 Bucket Grid

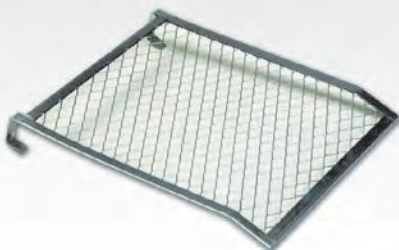

Code Number	Tray Size	Packed Per Ctn	UPC 077089-
RM416	5 GAL	12	41612-1

RM405 Plastic Tray



Code Number	Tray Size	Packed Per Ctn	UPC 077089-
RM405	2 QT	12	41612-1

ROLLER SETS



Tradesman
9SS



- 1 QT. Metal Tray
- 9" Roller Frame
- 3/8" Nap Tradesman Roller Cover (Semi-Smooth)
- UPC 74096310167-2
- 12 Per Box

Tradesman
4SS-P



- Plastic Tray
- 4" Roller Frame
- 3/8" Nap Tradesman Roller Cover (Semi-Smooth)
- Latex Glove
- UPC 74096310473-4
- 16 Per Box

Tradesman
9SS-P



- 1 QT. Tray
- 9" Roller Frame
- 3/8" Nap Tradesman Roller Cover (Semi-Smooth)
- UPC 74096310169-6
- 12 Per Box

Tradesman
9SSBWTP



- 2 QT. Tray
- 9" Roller Frame
- 3/8" Nap Tradesman Roller Cover (Semi-Smooth)
- UPC 74096310171-9
- 12 Per Box

Tradesman
18THT-C



- Large Capacity Tray
- 18" Roller Frame
- 18" 3/8" Nap Tradesman Roller Cover (Semi-Smooth)
- UPC 74096310640-0
- 6 Per Box

Professional Line
9FGL3-DK



- 2 QT. Tray
- 9" Roller Frame
- Two 3/8" Pro-Line Glossdell Roller Covers (Semi-Smooth)
- UPC 74096310900-5
- 12 Per Box

3 Piece Paint Roller Kit
RS683



- 2 QT. Steel Tray
- 9" Roller Frame
- 3/8" Tradesman Roller Cover (Semi-Smooth)
- Extension Handle
- UPC 07708968312-7
- 12 Per Box

11 Piece Paint Roller Kit
RS611



- 2 QT. Steel Tray
- Tray Liner
- 9" Roller Frame
- Two 3/8" Tradesman Roller Covers (Semi-Smooth)
- Foam Trim Brush
- Extension Handle
- Paint Paddle
- 1-1/2" Quality Trim Brush
- 3" Roller Frame and 3/8" Roller Cover
- UPC 07708961112-0
- 12 Per Box

ROLLER SETS



MICROFIBER Twin Packs

Code Number	Roller Size	Nap Height	Packed Per Ctn	UPC 740963-
4-MFR3T/P	4"	3/8"	12	11137-4
6.5-MFR3T/P	6.5"	3/8"	12	11134-3



MICROFIBER 10 Pack

Code Number	Roller Size	Nap Height	Packed Per Ctn	UPC 740963-
4-MFR3CK	4"	3/8"	6	11138-1
6.5-MFR3CK	6.5"	3/8"	6	11135-0



Glossdel Twin Packs

Code Number	Roller Size	Nap Height	Packed Per Ctn	UPC 740963-
6.5GL2T/P	6.5"	1/4"	12	10352-2
4GL3T/P	4"	3/8"	12	10231-0
6.5GL3T/P	6.5"	3/8"	12	10230-3



Glossdel 10-Packs

Code Number	Roller Size	Nap Height	Packed Per Ctn	UPC 740963-
6.5GL2CK	6.5"	1/4"	6	10813-8
6.5GL3CK	6.5"	3/8"	6	10715-5
6.5GL4CK	6.5"	1/2"	6	10817-6



Lamdel Twin Packs

Code Number	Roller Size	Nap Height	Packed Per Ctn	UPC 740963-
4LD3T/P	4"	3/8"	12	10822-0
6.5LD3T/P	6.5"	3/8"	12	10823-7
6.5LD4T/P	6.5"	1/2"	12	10825-1



Lamdel 10-Packs

Code Number	Roller Size	Nap Height	Packed Per Ctn	UPC 740963-
6.5LD3CK	6.5"	3/8"	6	10827-5
6.5LD4CK	6.5"	1/2"	6	10829-9

Lamdel Bulk Unbagged

Code Number	Roller Size	Nap Height	Packed Per Ctn	UPC 740963-
6.5LD4S	6.5"	1/2"	100	10821-3

Woven Twin Packs

Code Number	Roller Size	Nap Height	Packed Per Ctn	UPC 740963-
4WL3T/P	4"	3/8"	12	10857-2
6.5WL3T/P	6.5"	3/8"	12	10858-9



Woven 10-Packs

Code Number	Roller Size	Nap Height	Packed Per Ctn	UPC 740963-
6.5WL3CK	6.5"	3/8"	6	10833-6

Woven Bulk Unbagged

Code Number	Roller Size	Nap Height	Packed Per Ctn	UPC 740963-
4WL3S	4"	3/8"	100	10830-5
6.5WL3S	6.5"	3/8"	100	10831-2

Foam Twin Packs

Code Number	Roller Size	Nap Height	Packed Per Ctn	UPC 740963-
4FMT/P	4"	3/8"	12	10860-2
6.5FMT/P	6.5"	3/8"	12	10861-9



Foam 10-Packs

Code Number	Roller Size	Nap Height	Packed Per Ctn	UPC 740963-
6.5FMCK	6.5"	3/8"	6	10837-4

MINI ROLLER COVERS PROFESSIONAL



Merino Lambskin

Code Number	Roller Size	Nap Height	Packed Per Ctn	UPC 740963-
6.5FL4S	6.5"	1/2"	12	10727-8
6.5FL6S	6.5"	3/4"	12	10743-8



Lintless

Code Number	Roller Size	Nap Height	Packed Per Ctn	UPC 740963-
6.5GL2S	6.5"	1/4"	100	10710-0
4GL4S	4"	1/2"	100	10714-8
6.5GL4S	6.5"	1/2"	100	10712-4
6.5GL6S	6.5"	3/4"	100	10713-1



Mohair Silky

Code Number	Roller Size	Nap Height	Packed Per Ctn	UPC 740963-
6.5BMS	6.5"	3/16"	100	10834-3

MINI ROLLER SETS & MINI KITS



Mini Frame & Cover Combos Lintless



Code Number	Nap Height	Roller Size	Length	Packed Per Ctn	UPC 740963-
424-GL3C	3/8"	4"	24"	12	10667-7
416-GL4C	1/2"	4"	16"	12	10864-0
6.524-GL4C	1/2"	6.5"	24"	12	10638-7

Mini Frame & Cover Combos Maize



Code Number	Nap Height	Roller Size	Length	Packed Per Ctn	UPC 740963-
416-LD3C	3/8"	4"	16"	12	10850-3
6.524-4D3C	3/8"	6.5"	24"	12	10848-0
6.524-LD4C	1/2"	6.5"	24"	12	10856-5

Mini Frame & Cover Combos Woven



Code Number	Nap Height	Roller Size	Length	Packed Per Ctn	UPC 740963-
416-WLC	3/8"	4"	16"	12	10874-9
6.524-WLC	3/8"	6.5"	24"	12	10856-5



4-FMS-K

- 2 Foam Covers
- 4" Mighty Roller Frame
- Plastic Tray
- 2 Latex Gloves

Code Number	Roller Size	Packed Per Ctn	UPC 740963-
4-FMS-K	4"	16	10880-0



4-WLS-K

- 2 Woven Covers
- 4" Mighty Roller Frame
- Plastic Tray
- 2 Latex Gloves

Code Number	Roller Size	Packed Per Ctn	UPC 740963-
4-WLS-K	4"	16	10881-7

MINI ROLLER SETS

416-OHR

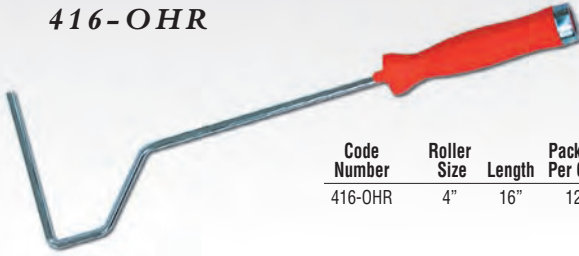

Code Number	Roller Size	Length	Packed Per Ctn	UPC 740963-
416-OHR	4"	16"	12	10876-3

4" Mighty Mini DUO
RF650

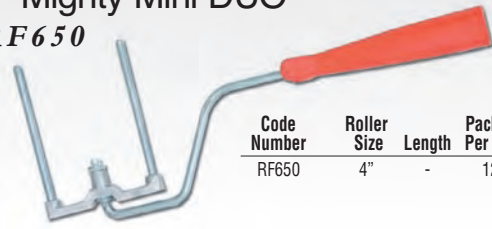

Code Number	Roller Size	Length	Packed Per Ctn	UPC 077089-
RF650	4"	-	12	65007-5

4" Rod Frames
RF100-11"



RF100-22"

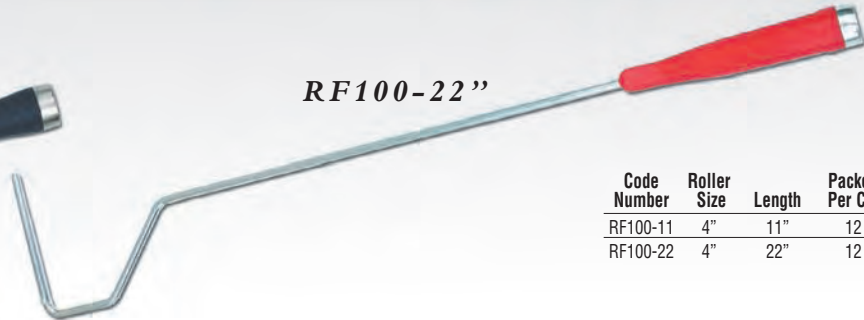

Code Number	Roller Size	Length	Packed Per Ctn	UPC 077089-
RF100-11	4"	11"	12	10011-2
RF100-22	4"	22"	12	10022-8

6.5" Rod Frames
RF602-11"

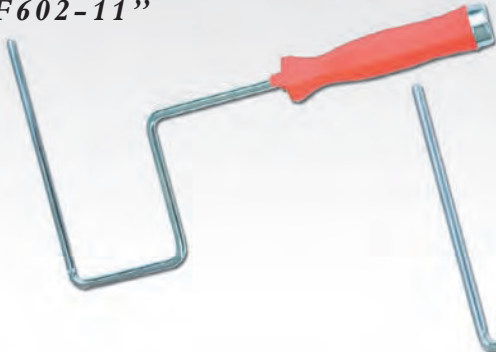

RF603-22"

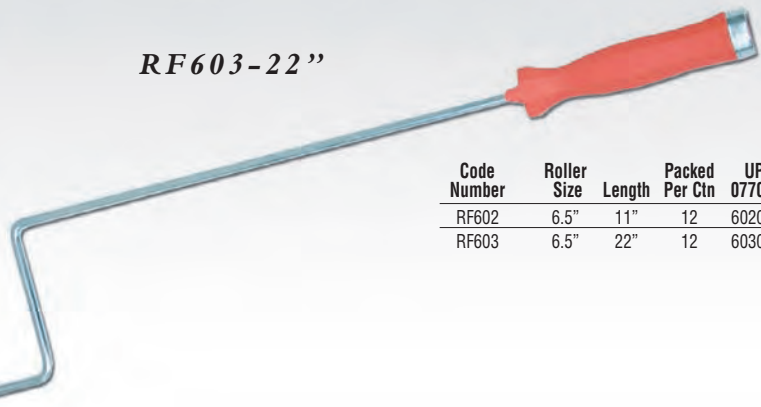

Code Number	Roller Size	Length	Packed Per Ctn	UPC 077089-
RF602	6.5"	11"	12	60200-5
RF603	6.5"	22"	12	60300-2

4" Reach N' Paint
RS106



Code Number	Roller Size	Length	Packed Per Ctn	UPC 077089-
RS106	4"	16"	12	10600-8

Unlike anything in the industry today! Great for hard to reach areas and many other odd jobs. Fits most standard mini rollers, foam, fabric, flock and tight spot style covers. Great for railings, radiators, wrought iron and hard to reach trim areas. The curve of the frame allows for easy dipping in any standard tray, paint bucket or pail.

PRO60 Pipe Roller Complete 6" • PRO65 Refill for PRO60



Code Number	Roller Size	Length	Packed Per Ctn	UPC 077089-
PRO60-pipe roller complete 6"	165 x 13	6-1/2" x 1/2"	10	160608
PRO65-refill for PRO60	165 x 13	6-1/2" x 1/2"	10	160653

PAD PAINTERS



10" Heavy Duty Exterior Pad Painter



8100-10"

Code Number	Size	Packed Per Ctn	UPC 077089-
8100N 10"	10"	6	81001-1

10" Pad Refill



8110-10"

Code Number	Size	Packed Per Ctn	UPC 077089-
8110 10"	10"	6	81100-1

9" Pad Painter



8000-9"

Code Number	Size	Packed Per Ctn	UPC 077089-
8000N 9"	9"	6	80009-8

9" Pad Refill



8010-9"

Code Number	Size	Packed Per Ctn	UPC 077089-
8010N	9"	6	80109-5

7" Pad Painter



8000-7"

Code Number	Size	Packed Per Ctn	UPC 077089-
8000 7"	7"	6	80006-7

7" Pad Refill



8010N 7"

Code Number	Size	Packed Per Ctn	UPC 077089-
8010	9"	6	80106-4

10" Corrugated Pad Painter



8200-10"

Code Number	Size	Packed Per Ctn	UPC 077089-
8200-10"	7"	6	80006-7

10" Pad Refill



8210 10"

Code Number	Size	Packed Per Ctn	UPC 077089-
8210-10"	10"	6	82100-0

5" Wheeled Paint Pad Edger



8003, 8013 (Refill)

Code Number	Size	Packed Per Ctn	UPC 077089-
8003	5"	6	08003-2
8013	5"	12	80135-4

Styrofoam Handle Disposable Pad Painter



8006

Code Number	Size	Packed Per Ctn	UPC 077089-
8006	-	12	80060-9

Corner Pad Painter



8002

Code Number	Size	Packed Per Ctn	UPC 077089-
8002	-	6	80020-3

1" Pad Painter-Arrow Tip



8001

Code Number	Size	Packed Per Ctn	UPC 077089-
8001	1"	6	80011-1

PAD PAINTERS

FOAM APPLICATORS



1" Foam Trimmer Edger Roller



RT301

Code Number	Size	Packed Per Ctn	UPC 077089-
RT301	1"	12	30105-2

3" Foam Roller



RT303

Code Number	Size	Packed Per Ctn	UPC 077089-
RT303	3"	12	30305-6

3" Foam Applicator Refill for RT303



RT3032

Code Number	Size	Packed Per Ctn	UPC 077089-
RT3032	3"	12	30325-4

3" Maxi Trimmer Foam Roller



RT308

Code Number	Size	Packed Per Ctn	UPC 077089-
RT308	3"	12	30805-1

3" Foam Applicator Refill Twin Pack



RT3082

Code Number	Size	Packed Per Ctn	UPC 077089-
RT3082	3"	12	30820-4

Beveled Foam Roller



RT320

Code Number	Size	Packed Per Ctn	UPC 077089-
RT320	-	12	32000-8

4" Foam Roller Refill for RT404



RT4042

Code Number	Size	Packed Per Ctn	UPC 077089-
RT4042	4"	12	40420-3

4" Mini Roller With Frame



RT404

Code Number	Size	Packed Per Ctn	UPC 077089-
RT404	4"	12	40406-7

6-1/2" Foam Roller with 12" Frame



RS601

Code Number	Size	Packed Per Ctn	UPC 077089-
RT601	6"	12	60110-7

6-1/2" Foam Roller Refill for RS601 & RS602



RT6012

Code Number	Size	Packed Per Ctn	UPC 077089-
RT6012	6-1/2"	12	60127-5

6-1/2" Foam Roller with 21" Frame

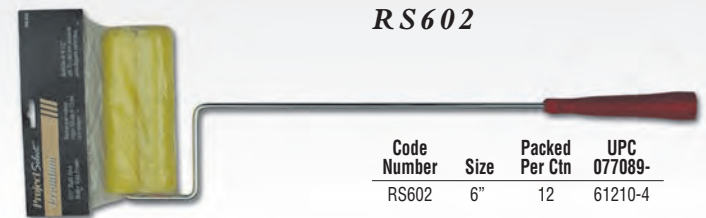

RS602

Code Number	Size	Packed Per Ctn	UPC 077089-
RS602	6"	12	61210-4

3" Trim Roller Tray & Foam Brush Set



RS3033

Code Number	Size	Packed Per Ctn	UPC 077089-
RS3033	3"	12	30330-8

Red Paint Can Grid



RM115

Code Number	Size	Packed Per Ctn	UPC 077089-
RM115	-	12	00115-0

FOAM APPLICATORS

BLOCK APPLICATORS



Lambskin Block Applicators



Code Number	Size	Packed Per Ctn	UPC 740963-
5LBC	5"	12	10918-0
10LBC	10"	12	10202-0
12LBC	12"	12	10236-5
14LBC	14"	12	10333-1
16LBC	16"	12	10334-8
18LBC	18"	12	10256-3

Synthetic Block Applicators

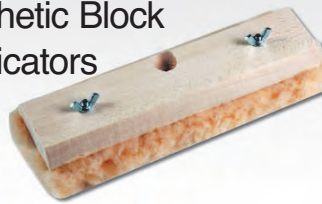

Code Number	Size	Packed Per Ctn	UPC 740963-
10ABC	10"	12	10186-3
12LBC	12"	12	10331-7

Flock/Foam Block Applicators

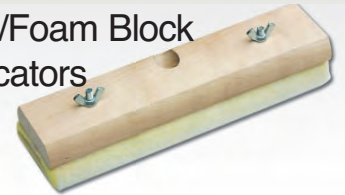

Code Number	Size	Packed Per Ctn	UPC 740963-
10FBC	10"	12	10212-9
12FBC	12"	12	10255-6
14FBC	14"	12	10281-5
16FBC	16"	12	10289-3
18FBC	18"	12	10285-3

Block Applicators are made with hardwood blocks and are available with several different types of fabrics. Refill pads and wood blocks are also available separately.

Lambskin Block Applicator Refills



Code Number	Size	Packed Per Ctn	UPC 740963-
10LBR	10"	12	10201-3
12LBR	12"	12	10241-9
14LBR	14"	12	10320-1
16LBR	16"	12	10321-8
18LBR	18"	12	10322-5

Synthetic Block Applicator Refills



Code Number	Size	Packed Per Ctn	UPC 740963-
10ABR	10"	12	10185-6
12ABR	12"	12	10332-4

Flock/Foam Refills



Code Number	Size	Packed Per Ctn	UPC 740963-
10FBR	10"	12	10213-6
12FBR	12"	12	10279-2
14FBR	14"	12	10280-8
16FBR	16"	12	10282-2
18FBR	18"	12	10284-6

ACCESSORIES



Lambswool Swab

LB



Code Number	Packed Per Ctn	UPC 740963-
LB	36	10489-5

Synthetic Fabric Swab

RT365



Code Number	Packed Per Ctn	UPC 077089-
RT365	36	36500-9

Lambskin Painters Mitt

LM



Code Number	Packed Per Ctn	UPC 740963-
LM	36	10180-1

Synthetic Painters Mitt

PM



Code Number	Packed Per Ctn	UPC 740963-
PM	12	10179-5

Econo Frame and Cover Units

RT413

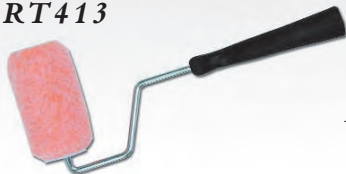

Code Number	Length	Packed Per Ctn	UPC 077089-
RT413	4"	12	41307-6

Econo Frame and Cover Units

RT300



Code Number	Length	Packed Per Ctn	UPC 077089-
RT300	3"	12	30005-5

Splatter Shield

7938



Code Number	Length	Packed Per Ctn	UPC 077089-
7938	9"	12	79389-5

Midget Wire Frame & Cover

RT315



Code Number	Length	Packed Per Ctn	UPC 077089-
RT315	3"	12	31505-9

BLOCK APPLICATORS

ACCESSORIES

ACCESSORIES



Driveway Squeegee

DVS11



Code Number	Packed Per Ctn	UPC 077089-
DVS11	24	02130-5

Lid Openers



5421: 1 GAL metal paint can lid opener and bottle opener, carded.

Code Number	Packed Per Ctn	UPC 077089-
5421	24	54210-3

5425: 5 GAL plastic lid opener in poly bag with header.

Code Number	Packed Per Ctn	UPC 077089-
5425	24	54250-9

Mixers



M101
M505

Fits All Drills 3/8" and Larger
M101 Overall Length is 16"
M505 Overall Length is 23-1/2"

Code Number	Size	Packed Per Ctn	UPC 077089-
M101	1 GAL	6	01010-7
M505	5 GAL	6	00505-9

Spinner & Paint Cleaner



6006

Deluxe heavy duty metal brush and roller cleaner

Code Number	Packed Per Ctn	UPC 077089-
6006	6	60060-5

Caulking Guns

Skeleton Frame
6003-6004

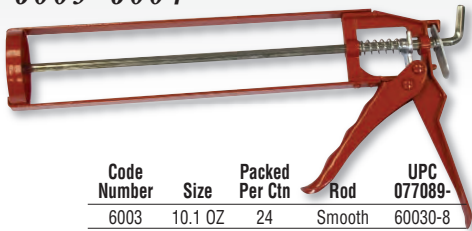

Code Number	Size	Packed Per Ctn	Rod	UPC 077089-
6003	10.1 OZ	24	Smooth	60030-8
6004	1 QT	12	Smooth	60040-7

Caulking Guns

Standard Frame
6000-6001-6002

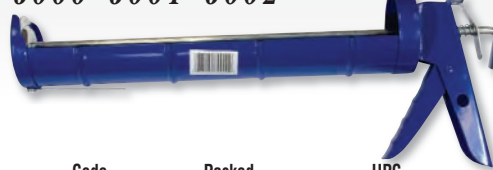

Code Number	Size	Packed Per Ctn	Rod	UPC 077089-
6000	10.1 OZ	24	Smooth	60000-1
6001	10.1 OZ	24	Ratchet	60010-0
6002	1 QT	6	Smooth	60020-9

Caulking Gun

CHROME

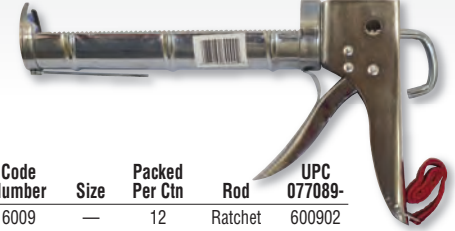

Code Number	Size	Packed Per Ctn	Rod	UPC 077089-
6009	—	12	Ratchet	60090-2

Sanding Blocks

MF10 • MC11

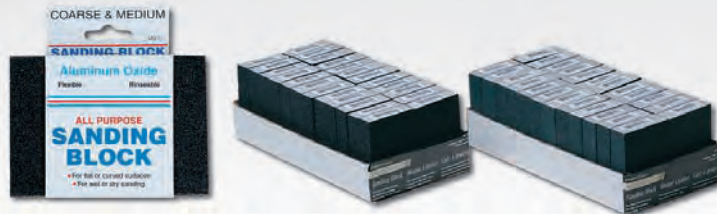

Code Number	Grit	Packed Per Ctn	UPC 077089-
MF10	Medium/Fine	24	00010-8
MC11	Medium/Coarse	24	00011-5

SB100



Code Number	Packed Per Ctn	UPC 077089-
SB100	24	10000-6

Magne-Clip 5095



Clip to your paint bucket and stick the metal ferrule of your brush to the magnet!

Code Number	Packed Per Ctn	UPC 740962-
5095	24	50950-9



Project Select Multi Purpose PolyTarp

- Waterproof
- Heavy Duty Laminated Polyethylene
- Reusable & Washable
- UV Resistant • Reinforced Edges
- Tear Resistant • Midew Proof

Code Number	Length	Packed Per Ctn	UPC 077089-
T0608	6' x 8'	24	06080-5
T0810	8' x 10'	12	08100-8
T0912	9' x 12'	12	09120-5
T1012	10' X 12'	12	10120-1
T1020	10' X 20'	6	10200-0
T1212	12' X 12'	6	12120-9
T1216	12' X 16'	6	12160-5
T1620	16' X 20'	6	16200-4
T2020	20' X 20'	4	20200-7
T2030	20' X 30'	2	20300-4
T3050	30' X 50'	1	03050-1
T4060	40' X 60'	1	04060-9

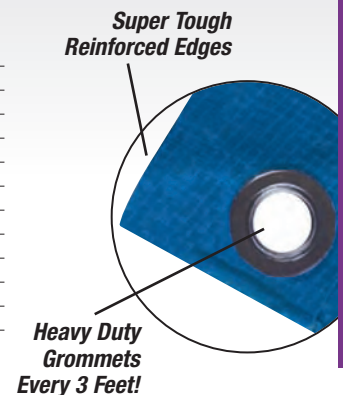

ACCESSORIES

DROP CLOTHS & WIRE BRUSHES



Drop Cloths



KL E-10



KL-300x3



KL E-30

Code Number	Size	Grade	Thickness	Packed Per Ctn	UPC 077089-
KL-300	9' x 12'	Utility	0.3 Mil	72	03000-6
KL-300x3	9' x 12'	Utility 3pk	0.3 Mil	36	03003-7
KL-E50	9' x 12'	Standard	0.4 Mil	36	00500-4
KL-600	9' x 12'	Heavy	1.5 Mil	12	06000-3
KL-E120	10' x 25'	Heavy	1.0 Mil	12	01200-2
KL-E10	9' x 12'		1.0 Mil	24	00100-6
KL-E20	9' x 12'		2.0 Mil	12	00200-3
KL-E30	9' x 12'		3.0 Mil	12	00300-6

310

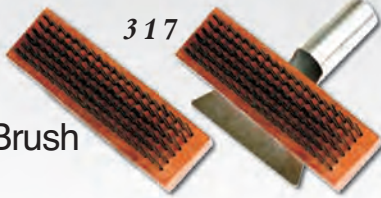

317

- Rows: 19 x 6
- 7" L, 2-1/8" W
- 317: Scraper

Code Number	Packed Per Ctn	UPC 077089-
310	12	31000-9
317	12	31700-8



- Rows: 19x6
- 7" L, 2-1/8" W
- Hardened Stainless Steel Wires
- Rubberized Soft Grip

Code Number	Packed Per Ctn	UPC 077089-
WB619SS	12	61900-3

Standard Wire Brush

WB 319 SS SC



- Rows: 19x3
- 14" L, 1" W
- Hardened Stainless Steel Wires
- Rubberized Soft Grip

Code Number	Packed Per Ctn	UPC 077089-
WB319SSSC	6	31901-9

WB 416 SS SC • WB 411 SS SC



- 416: Rows: 16x4
- 11" L, 1" W
- 411: Rows: 11x4
- 11-1/2" L, 1-1/2" W

Code Number	Packed Per Ctn	UPC 077089-
WB416SSSC	12	41600-8
WB411SSSC	12	41101-0

- Rubberized Soft Grip
- Hardened Stainless Steel Wires

Standard Wire Brush

300



- Shoe Handle
- Rows: 16x4
- 11" L 1" W

Code Number	Packed Per Ctn	UPC 077089-
300	12	30000-0

Standard Wire Brush

300SC



- Shoe Handle
- Scraper
- Rows: 16x4
- 11" L 1" W

Code Number	Packed Per Ctn	UPC 077089-
300SC	12	30001-7

Standard Wire Brush

305SC



- Rows: 3x19
- 11-3/4" L, 15/16" W
- Scraper

Code Number	Packed Per Ctn	UPC 077089-
305SC	12	30501-2

Mini Brass Wire Brush

301



Code Number	Packed Per Ctn	UPC 077089-
301	12	30100-7

Mini Stainless Wire Brush

302



Code Number	Packed Per Ctn	UPC 077089-
302	12	30200-4

Mini Nylon Brush

303



Code Number	Packed Per Ctn	UPC 077089-
303	12	30300-1



Mini Wire Brush Sets

C 301

Code Number	Packed Per Ctn	UPC 077089-
C301	12	30101-4

3 brass wire brushes, carded.



Mini Wire Brush Sets

C 302

Code Number	Packed Per Ctn	UPC 077089-
C302	12	30201-1

2 stainless wire brushes, carded.



Mini Nylon Brush Sets

C 303

Code Number	Packed Per Ctn	UPC 077089-
C303	12	30301-8

2 nylon wire brushes, carded.



Mini Wire Brush Sets

C 332

Code Number	Packed Per Ctn	UPC 077089-
C332	12	33200-1

1 stainless and 1 nylon wire brush, carded.

DESIGN A RACK PROGRAM



DESIGN A RACK PROGRAM



E



F



G



H



I

DISPLAY RACKS

- A Order \$1,500 of any professional line brushes and get this display free. Limit – one to a customer. 48-1/4" wide x 54" high x 16-3/4" deep
- B Order \$2,000.00 of any professional line brushes, trays, and applicator pads and get this display free. Limit – one to a customer. 48-1/4" wide x 54" high x 16-3/4" deep
- C Order \$1,200.00 of professional line roller covers and receive this display with special roller bins free. Limit – one to a customer. 48-1/4" wide x 54" high x 16-3/4" deep
- D \$1,000.00 Mix and match professional line brushes and tradesman quality brushes andsets and receive this display free. Limit – one to a customer. 36-3/8" wide x 54" high x 16-3/4" deep
- E Order \$850.00 of professional line brushes and rollers and receive this display free. Limit – one to a customer. 24-1/4" wide x 54" high x 16-3/4" deep
- F Order \$750.00 of tradesman quality brushes and rollers and receive this 24" display free. Limit – one to a customer. 24-1/4" wide x 54" high x 16-3/4" deep
- G Order \$600.00 of mini rollers, frames and sets and receive this 24" display free. Limit one to a customer 24-1/4" wide x 54" high x 16-3/4" deep.
- H Receive this handy display that will hold up to 36 extension poles when you buy 36 pcs – any combination of extension poles. 21-3/4" wide x 16-1/2" high x 13-1/2" deep
- I Mini Brush assortment displays are available in all Professional Brush Series. The display is designed to hold 4 brushes each—1-1/2", 2", 2-1/2" and 3."

Accessories33-34

- Caulk guns34
- Frame and Covers Econo . . .33
- Lid Openers34
- Magne-Clip34
- Mixers34
- Painters Mitt33
- Sanding Blocks34
- Spinner & Paint Cleaner . . .34
- Splatter Shield33
- Swabs33

Block Applicators33

- Flock/Foam33
- Lambskin33
- Synthetic33

Brushes3-15

- Anatomy1
- Artist Brushes16
- Badger8
- Bent Radiator Brushes14
- Bristle Ox9
- Cap N Jack8
- Chip (Promotional) Brushes 12
- Classic7
- Finultra3
- Foam Brushes14
- Gold Frost4
- Gold Frost Plus6
- Hockey Brushes14
- Olympian13
- Paint Mate11-12
- Pro Tradesman9
- Red Frost5
- Sets16
- Specialty Brushes15
- Stain Brushes13
- Tradesman Black China10
- Tradesman White China11
- Tradesman Polyester10
- White Pearl8

Extension Poles22

Foam Applicators32

- Foam Applicator Refills32
- Foam Roller & Brush set . . .32

Roller Covers17-20

- Anatomy2

9" Professional Rollers 17-18

- Glossdel-White17
- Lamdel-Maize18
- Merino Lambskin17
- Microfiber17
- Prodel Blue18
- Viodel Purple17

9" Multi-Packs22

- Economy Tri-Pack22
- Economy 4-Pack22
- Economy 6-Pack22
- Glossdel 4-Pack22
- Lamdel 4-Pack22
- Paint Mate-Melon 2-Pack . . .22

18" Professional Rollers . . .20

- Glossdel-White20
- Lamdel-Maize20
- Microfiber20
- Prodel-Blue20
- Viodel-Purple20

Foam Rollers21

- Slit Foam21
- Twin Packs21

Paint Mate-Melon19

Specialty Rollers19

- Carpet-Gray19
- Mohair-Red19
- Stipple Brown19
- Texture-Goop19

Tradesman -Orange18

9" Roller Frames23-24

- Adjustable Roller Frame24
- Closed Core Frame24
- DUO24
- Economy23
- Golden Eagle23
- Jumbo23

9" Roller Frames (continued)

- Twist 2 Extend23
- White condor23

Roller Sets27

- Econo Frame and Covers . . .24

Roller Trays25-26

- Bucket Grids26
- Metal Roller Trays25
- Plastic Roller Trays25
- Tray Liners26

Mighty Mini28-29

- Foam twin Packs28
- 10 Packs28
- Glossdel Twin Packs28
- 10 Packs28
- Lamdel Twin Packs28
- Bulk Unpackaged28
- 10 Packs28
- Lintless Singles29
- Merino Singles29
- Mohair-Silky Singles29
- Woven Twin Packs28
- Bulk Unpackaged28
- 10 Packs28

Mini Frame & Cover Combos .29

- Lintless29
- Maize29
- Mini Kits29
- Woven29

Mini Frames30

- DUO30
- Reach N' Paint30

Pad Painters31

- Pad Painter Refills31

Wire Brushes35

- Mini Wire Brush Sets35
- Poly-Tarps34



ArrowWorthy

248 WYANDANCH AVENUE • WEST BABYLON, NY 11704
Telephone: 631-643-0436 • Toll Free: 888-444-4949
Fax: 631-253-9428 • Toll Free Fax: 866-272-8038
web: www.arroworthy.com



CLAREMONT, NH



MIDWEST DIVISION, KANKAKEE, IL



WESTERN DIVISION, SAN FERNANDO, CA

